

# **MOTAS-6**

## **SYNTHESIZER**

## **User Guide**

document version 1.23 (non-printed)

for firmware version 06020110

May 22, 2020

# Contents

<b>1</b>	<b>Foreword</b>	1
<b>2</b>	<b>Proper use and maintenance</b>	2
<b>3</b>	<b>Document conventions</b>	3
<b>4</b>	<b>Introduction</b>	4
<b>5</b>	<b>Top and rear panel</b>	6
<b>6</b>	<b>Quick-start</b>	7
<b>7</b>	<b>Control Overview</b>	8
<b>8</b>	<b>Parameter pages</b>	9
8.1	Parameter page display overview	10
<b>9</b>	<b>Modulation</b>	12
9.1	MIDI / CV Modulations	12
9.2	Low-Frequency Oscillator (LFO) waveforms	15
9.3	Global Low-Frequency Oscillators (LFOx)	15
9.4	Dedicated Low-Frequency Oscillators (LFO)	17
9.5	Envelope Generators (EG)	19
<b>10</b>	<b>Parameter pages - in depth</b>	21
10.1	Master Pitch	21
10.2	Oscillator 1	21
10.3	Oscillator 2	23
10.4	Oscillator 3	24
10.5	Mixer section	26

10.6	Low-pass filter 1 . . . . .	27
10.7	High-pass filter . . . . .	28
10.8	Low-pass filter 2 . . . . .	28
10.9	Output stage . . . . .	29
<b>11</b>	<b>Patch summary . . . . .</b>	<b>30</b>
<b>12</b>	<b>Load, save and copy . . . . .</b>	<b>31</b>
12.1	Load patch . . . . .	31
12.2	Save and erase patches . . . . .	31
12.3	Copy/Reset/Randomise . . . . .	32
<b>13</b>	<b>Vector morphing . . . . .</b>	<b>33</b>
<b>14</b>	<b>Arpeggiator . . . . .</b>	<b>34</b>
14.1	Main arpeggiator settings . . . . .	34
14.2	More arpeggiator settings . . . . .	34
14.3	Internal arpeggiator settings . . . . .	35
<b>15</b>	<b>Pattern sequencer . . . . .</b>	<b>36</b>
15.1	Control overview . . . . .	36
15.2	Pattern edit mode . . . . .	36
15.3	Load/save/copy patterns . . . . .	37
15.4	Sequence edit mode . . . . .	38
15.5	Load/save sequences . . . . .	38
<b>16</b>	<b>Monitor . . . . .</b>	<b>39</b>
16.1	Volume level monitor . . . . .	39
16.2	MIDI in monitor . . . . .	39
16.3	Oscilloscope . . . . .	40
16.4	Spectrum analyser . . . . .	40
<b>17</b>	<b>Setup . . . . .</b>	<b>42</b>
17.1	Patch settings 1 . . . . .	42
17.2	Patch settings 2 . . . . .	42
17.3	Tempo settings . . . . .	42
17.4	MIDI channels . . . . .	43
17.5	Modulators . . . . .	43

17.6	Morph/patch change . . . . .	43
17.7	CV/Gate inputs . . . . .	44
17.8	CV/gate offset and scaling. . . . .	44
17.9	Tuning . . . . .	44
17.10	SysEx data backup . . . . .	45
17.11	NRPN control + SysEx . . . . .	46
17.12	System settings . . . . .	46
17.13	Custom settings . . . . .	46
17.14	Calibration . . . . .	46
17.15	Calibration values . . . . .	47
17.16	System status . . . . .	47
17.17	Version info . . . . .	47
<b>18</b>	<b>Real-time patch change recording . . . . .</b>	<b>48</b>
<b>I</b>	<b>Signal path diagram (simplified) . . . . .</b>	<b>50</b>
<b>II</b>	<b>Glossary. . . . .</b>	<b>51</b>
<b>III</b>	<b>MIDI Implementation Chart . . . . .</b>	<b>54</b>
<b>IV</b>	<b>MIDI SysEx messages . . . . .</b>	<b>57</b>
<b>V</b>	<b>Specifications . . . . .</b>	<b>58</b>
<b>VI</b>	<b>EU Declaration of Conformity . . . . .</b>	<b>59</b>

# 1 Foreword

Thank you for taking the time to read this user guide.

The **MOTAS-6** synthesizer is the result of many years of development to create a great-sounding instrument with very comprehensive modulation capabilities and an easy to use and responsive interface.

To get the most out of this powerful synthesizer we recommend you study this guide carefully whilst practising and listening at the same time. You cannot beat hands-on experience!

We hope you will find using **MOTAS-6** an enjoyable experience and discover some great new sounds.

For the latest news and updates please visit our website <https://www.motas-synth.uk>.

For technical support, general enquiries or user feedback (gratefully received) please email [support@motas-synth.uk](mailto:support@motas-synth.uk)

Whilst every effort has been made to ensure that this guide is as accurate as possible Motas Electronics Limited will not be liable for any erroneous information. This manual may be updated at any time without prior notice. Please check the website for updates.

This guide or any portion of it may not be reproduced in any form without the manufacturer's express consent.

## 2 Proper use and maintenance



Please read the following instructions carefully and keep them with the apparatus. Do not operate the apparatus until you have read and understood this section.

### Proper use

- Only use a correctly specified power supply otherwise damage may occur to the apparatus and/or other connected equipment.
- Place the apparatus on a stable surface.
- Never use the apparatus under damp conditions. Do not expose the apparatus to rain. Use the apparatus in enclosed rooms only.
- Unplug the apparatus during lightning storms or when unused for long periods of time.
- Never operate the apparatus or power supply with wet hands and never place objects containing liquids on or near the apparatus.
- Do not use the apparatus in extremely dusty or dirty environments.
- The rear left of the chassis gets very warm in normal use – make sure that adequate ventilation is available. Do not place the apparatus near heat sources such as radiators.
- Make sure no foreign objects find their way into the chassis. If for some reason this should occur, switch the power off, unplug the device and consult qualified service personnel.
- Do not expose the apparatus to direct sunlight as this could damage the display and fade the surface finish.
- Do not expose the apparatus to extreme vibrations.
- Refer all servicing to qualified service personnel. Servicing is required when the apparatus has been damaged (or potentially has been damaged) e.g. power connections damaged, liquid spilled or objects have fallen into the apparatus, the apparatus has been exposed to rain or moisture, apparatus does not operate normally or has been dropped.
- The apparatus, used on its own or with amplifiers, speakers or headphones, can generate volume levels that may do irreparable damage to your hearing.

- The apparatus is designed exclusively to produce low-frequency audio signals for the purpose of generating sound. Any other use is prohibited. Motas Electronics Limited is not liable for damages due to incorrect use.

### Maintenance

- Do not open the apparatus or remove the cover. Refer all service and repair tasks to qualified personnel. The interior of the chassis contains no components that require user maintenance.
- Use a soft cloth (e.g. a micro-fibre cloth) or brush to clean the device. Never use alcohol, cleaning solutions or similar chemicals as they will likely damage the surface finish of the chassis and/or the markings.



The symbol below indicates that this product must not be disposed of with your other household waste. Instead, it is your responsibility to dispose of your waste equipment by handing it over to a designated collection point for the recycling of waste electrical and electronic equipment. The separate collection and recycling of your waste equipment at the time of disposal will help conserve natural resources and ensure that it is recycled in a manner that protects human health and the environment. For more information about where you can drop off your waste for recycling, please contact your Local Authority, or where you purchased your product.



### 3 Document conventions

You will find many screenshots taken from **MOTAS-6** throughout this guide. An example is shown below:

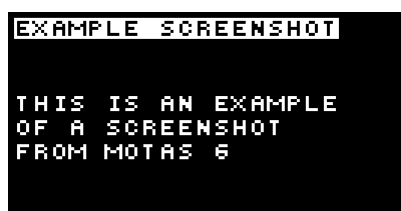

The following document formatting conventions are used:

- [Link](#) (blue text) is a weblink or a link to another part of this document.
- ❶ (number) refers to an item on the top panel of the unit.
- Ⓐ (letter) refers to an item on the rear panel of the unit.
- **THIS** or **THIS** shows text you may see on the display.
- 🖱️ shows a symbol you may see on the display.
- 🖱️ **TEXT** or 🖱️ 📄 refers to a push button on the top panel labelled with that text or symbol.
- 🔄 **TEXT** or 🔄 📄 refers to a rotary knob on the top panel labelled with that text or symbol.
- 🌀 refers to the rotary encoder data-entry wheel on the lower RHS of the front panel.



Tip section highlighted with a 'lightbulb' icon.



Information section highlighted with an 'i' icon.



Advanced information section highlighted with a 'gears' icon. These may be advanced patch tips or details of the inner workings of **MOTAS-6**. It is not necessary to understand these sections to successfully use **MOTAS-6**.



Warning section highlighted with a 'warning' icon. It is important to ensure that you read and understand these sections.

## 4 Introduction

**MOTAS-6** is a paraphonic vector-morphing synthesizer with classic analogue subtractive synthesis and powerful digital control.

- Vector morphing between patches
- Fully analogue audio signal path
- Three analogue oscillators (VCOs) with freely mixable waveforms:
  - triangle (oscillators 1, 2 and 3)
  - sawtooth (oscillators 1, 2 and 3)
  - variable-width pulse (oscillators 1 & 3)
  - square and sub-oscillator (oscillator 2)
- Oscillator hard-syncing (multiple options)
- Analogue phase modulation (oscillators 2 & 3)
- Analogue noise source (white or pink)
- Internal audio feedback or external audio input
- 4 CV/gate inputs for analogue control
- Three independent analogue filters (VCFs) with flexible routing:
  - Low-pass resonant filter (6-pole with selectable outputs and resonance character adjustment)
  - Second low-pass resonant filter (4-pole)
  - High-pass filter (2-pole)
- Multiple output distortion options
- Powerful modulation architecture:
  - 4 global LFOs (Low Frequency Oscillators)
  - 4 global EGs (Envelope Generators)
  - 33 parameter-local LFOs
  - 33 parameter-local EGs
  - Four freely configurable modulation sources from MIDI and CV/gate inputs
- Quick-access buttons to 5 active patches
- Copy/reset/randomise feature
- Full MIDI control and USB MIDI interface
- Oscilloscope and spectrum analyser
- Flexible arpeggiator
- Built-in pattern sequencer
- Non-volatile internal memory for saving 500 patches, 56 patterns, 16 sequences and user settings

- High-resolution OLED graphic display
- Compact high-quality tabletop case

### Vector morphing

**MOTAS-6** has a unique 'vector morphing' feature. This allows blending of the parameters for the active patch in a 2-D space from a set of 4 patches using the morph-x and morph-y modulators (which can be freely assigned to any MIDI controller or CV signal).

### Analogue oscillators

**MOTAS-6** has three analogue voltage-controlled oscillators (VCOs) with various hard-sync, pulse-width and phase modulation options. These are true analogue oscillators and *not* DCOs. The oscillators, analogue noise source (with white/pink output option) and an internal feedback routing or external audio input all feed into a mixer before the filters.

### Analogue filters

**MOTAS-6** has very powerful filtering capabilities. There is a 6-pole voltage-controlled low-pass filter (VCF) with adjustable resonance to self-oscillation (with selectable 1, 2, 3, 4, 5 and 6-pole outputs), a 2-pole high-pass filter and a second 4-pole low-pass filter with adjustable resonance to self-oscillation.

The filters can be chained in parallel or in series and the outputs are separately mixable giving huge sound-creation potential. The final audio output has a variety of clipping distortion options.

### Modulation

Each analogue-controlled parameter has its own dedicated LFO and EG. In addition, each parameter has dedicated modulation amount settings from velocity, pitch, the global modulation sources and the global LFOs and EGs. Secondary 'modulation of the modulators' is also possible, for example, a global modulation source can control the LFO frequency. This allows very flexible and powerful control of the analogue sound.



Up to four global modulation sources can be freely defined from incoming MIDI controller data and/or analogue signals on the CV/gate inputs.



The internal architecture uses high-resolution digital signals for the modulation allowing a total of 37 LFOs and 37 EGs.



## User interface

Dedicated analogue rotary potentiometers  are used to access the basic analogue parameter pages and to allow fast 'tweaking' in real-time. In addition **MOTAS-6** uses a rotary rotary encoder  in combination with tactile push buttons  for data entry and editing.

## Display

**MOTAS-6** has an OLED (organic light emitting diode) display with a fast update rate and wide viewing angle. The display intensity can be adjusted.

## External connections

**MOTAS-6** has traditional MIDI input and MIDI output connectors in addition to USB MIDI. USB MIDI allows faster data transfer to and from a PC and **MOTAS-6** is recognised as a standard MIDI device (no special drivers should be needed).

There are four independent analogue CV/gate inputs to allow playing/modulation from external analogue sequencers, controllers and modular synthesizers.

The main audio output is monophonic and in addition there is a mono headphone output (on a stereo connector).

## Other features

**MOTAS-6** has a flexible arpeggiator. There are global and patch-specific arpeggiator settings. The play mode, octave range, pattern, note length and swing can be adjusted and synced to MIDI, CV or internal clock. A special global mode allows rapid patch changing as the arpeggiator plays.

The pattern sequencer allows 1-bar patterns to be entered where each note in each pattern can be adjusted for pitch, velocity, time, duration, micro-tune and patch change. Real-time sound parameter changes can be recorded and edited too. Patterns can be arranged into a 2-line simple sequence with pattern repeat, transpose, time offset and patch settings.

More than 500 sound patches can be saved to non-volatile memory.

**MOTAS-6** has 32 built-in microtuning scales and allows a further 32 scales to be defined and stored using standard MIDI bulk tuning commands.

There is a useful oscilloscope and spectrum analyser feature that allow the user to study the output signals on the display.

## Integration with external software

Free software including DAW plugin software is available to download from <https://www.motas-synth.uk/downloads>. This allows live control between **MOTAS-6** and your computer and patch/sequence archiving, firmware updating and more.

## Firmware updates

**MOTAS-6** firmware updates are available from time-to-time to add new features and make other improvements. These can be downloaded and applied using the free software provided from <https://www.motas-synth.uk/downloads>.

## 5 Top and rear panel

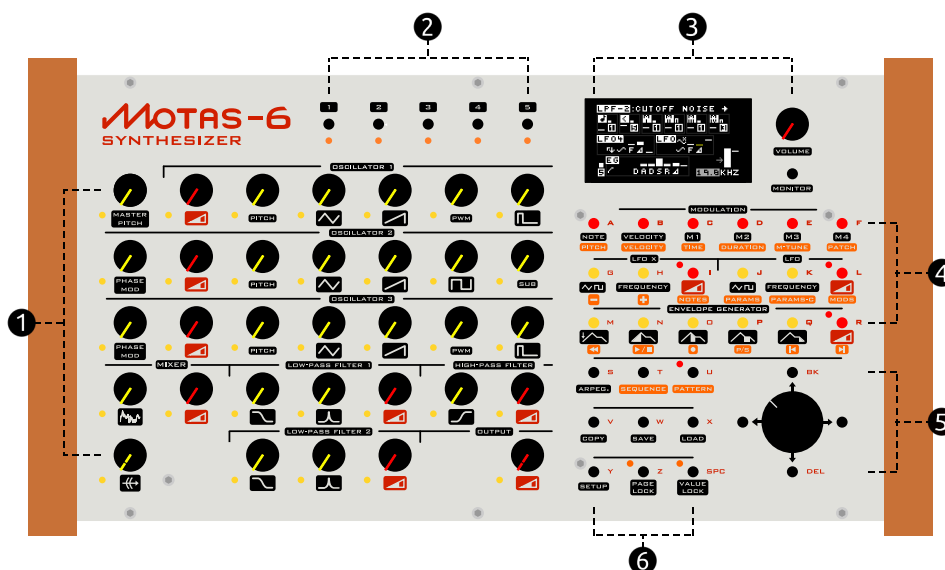

- ❶ sound editing 'parameter' knobs with LEDs [x 33]
- ❷ quick-access patch-change buttons with LEDs [x 5]
- ❸ OLED display (monochrome yellow or white), main volume knob and monitor button
- ❹ modulation settings / sequence control buttons [x 18]

- ❺ rotary encoder and buttons [x 4] for data entry/options†
- ❻ buttons to access other features [x 9]

† Panic combination: pressing the rotary encoder and simultaneously will turn off all playing notes and reset controllers. Useful if, for example, a controller keyboard is unplugged leaving notes hanging.

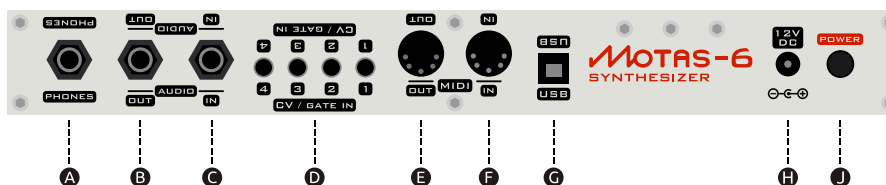

The lettering at the top of the rear panel is printed upside down so that the user can read the lettering when peering over from the top of the unit.

- ❶ headphones out (2 channel mono)  
[ Stereo 6.35mm phone socket ]
- ❷ main audio out (mono)  
[ Mono 6.35mm phone socket ]
- ❸ external audio input (leave unconnected for internal feedback routing)  
[ Mono 6.35mm phone socket ]
- ❹ CV/gate inputs [ 3.5mm sockets x 4 ]
- ❺ MIDI out [ 5-pin DIN socket ]

- ❻ MIDI in [ 5-pin DIN socket ]
- ❼ USB MIDI socket for connection to PC  
[ USB type-B ]
- ❽ power supply in  
[ 2.1mm. 12V DC, centre positive ]
- ❿ power on/off push switch  
[ button in = power on ]

## 6 Quick-start

1. Firstly ensure that the power button **J** is off and the main volume control **E** is set to minimum.

2. Plug a MIDI cable from your MIDI keyboard to the MIDI IN connector **F**. Turn on your MIDI keyboard and set it up to send MIDI notes as you play.

Alternatively connect **MOTAS-6** to your PC with a USB cable – it should appear as a standard MIDI device (once powered on). Use your sequencer or other software to send note data.

Ensure the **MOTAS-6** receive MIDI channel matches the send channel number – for more info see [17.4](#).

3. Plug a mono audio patch cable from the main audio out **B** to your external amplification system. Set the gain level low initially, to avoid any audio pops when **MOTAS-6** is switched on. Alternatively monitor on headphones **A**.

4. Plug in the 12V DC power supply into connection **H**.

5. Turn on **MOTAS-6** using the power button **J**. The display will show the start-up image.



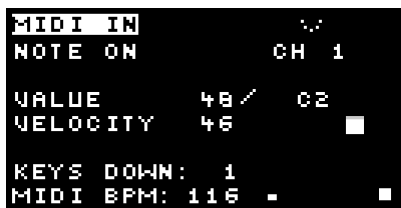

6. Press **MONITOR** (in the **3** group) and then the right arrow button **→**. The display will change and show MIDI diagnostics monitoring information for the incoming MIDI data if everything is working correctly. If you don't see this check your connections and external settings. For more information on the MIDI monitoring see [chapter 16](#).



7. Press **LOAD** (button in the **6** group). and then use the rotary encoder **O** to scroll through the available preset sounds (in bank 0). As each preset is selected the settings are loaded in and you should be able to hear audio as you play. For more information





on loading sounds see [chapter 12](#). Adjust the volume level control **E** to a suitable listening level.







## 7 Control Overview



To access the settings (parameters) that determine the sound you turn a rotary knob  1 corresponding to the setting that you want to change. Each rotary knob  1 is associated with it's own 'parameter page'. Normally the display will then change to show the settings for the parameter page associated with that knob.



For example, the figure above shows the parameter page for the low-pass filter 1 cut-off frequency. Here there is an EG set and the basic offset (ignoring modulation) has the cut-off frequency set to 19.5 kHz.

Turning a rotary knob  1 normally has the side-effect of also changing the offset value for that parameter page. Use the 'value lock' feature to allow changing of the active parameter page without changing the offset. Press the  **VALUE LOCK** button to toggle 'value-lock' on and off. When 'locked' the LED will flash next to the  **VALUE LOCK** button. Conversely, use the 'page-lock' mode to allow rapid hands-on changes of parameter basic offsets such as sweeping filter cut-off, changing oscillator mix levels etc. without changing the active parameter page. Press the  **PAGE LOCK** button to toggle 'page-lock' on and off. When 'locked' the LED will flash next to the  **PAGE LOCK** button.

Use the rotary encoder  or  ↑ or  ↓ buttons to change values. For faster data entry when using the rotary encoder , push the rotary encoder  down at the same time as turning. You can also press and hold  ↑ or  ↓ to rapidly change a value.

In the case of any 'stuck' notes e.g. if a MIDI keyboard is unplugged whilst a note is 'on', press and hold the rotary encoder  wheel down and simultaneously press  ↓ to turn all notes off.







Adjust  **VOLUME** to set the output volume level.

### Patch parameter editing



The sound generated by **MOTAS-6** is controlled by the settings on 33 parameter 'pages' – each parameter has

its own 'page' shown on the display. These are explained in detail in chapter 10. To access a particular parameter page turn the appropriate rotary knob  1. The active parameter page is shown by the adjacent flashing LED.

### Patch changing

**MOTAS-6** has 5 patches (sound setups) in memory ready for easy access. To change presets press one of the preset  2 buttons  1,  2,  3,  4 or  5. The corresponding preset  2 LED will be lit to show the active patch. See chapter 11 for more details.

### Load/save/copy

To load or save patches, patterns or sequences press  **LOAD** or  **SAVE**. To copy patch settings, reset settings or randomise parameter page settings press  **COPY**. See chapter 12 for more details.



### Vector morphing

**MOTAS-6** has a vector morphing feature to allow smooth transition from the sound parameters of one patch to another using external controllers. To access the vector morphing feature press  → whilst a preset page is displayed. See chapter 13 for more details.

### Arpeggiator

**MOTAS-6** has a powerful arpeggiator feature – press  **ARPEG.**. See chapter 14 for more details.

### Pattern sequence

**MOTAS-6** has a pattern sequencer. Press  **PATTERN** to access the patterns and  **SEQUENCE** to access the sequencer. See chapter 15 for more details.

### Monitor

To view signal level, the incoming MIDI signals and output signals and access the oscilloscope and spectrum analyser features use the 'monitor' feature  **MONITOR**. See chapter 16 for more details.

### Setup

To access various global settings and parameters (such as MIDI receive channel, calibration and modulation sources) press  **SETUP**. See chapter 17 for more details.

### Live sound changes



**MOTAS-6** can send and receive MIDI NRPN messages to allow external recording and control of patch settings. See chapter 18 for more details of NRPNs.

## 8 Parameter pages

The sound generated by **MOTAS-6** is controlled by the settings on 33 parameter 'pages' – each parameter has its own 'page' shown on the display. These are listed below and explained in detail in chapter 10. To access a particular parameter page turn the appropriate rotary knob 

1. The active parameter page is shown by the adjacent flashing LED indicator.



Use the 'value lock' feature to allow changing of the active parameter page without changing the sound parameters. Press the  **VALUE LOCK** button to toggle 'value-lock' on and off. When 'locked' the LED will flash next to the  **VALUE LOCK** button.











The listing below is a summary of each parameter page starting from the top left of the front panel moving from left-to-right and then down in rows.

### Parameter page summary





#### • Master pitch page:







 **MASTER PITCH** pitch control applied to all 3 oscillators

#### • Oscillator 1 pages:











-   overall volume level
-  **PITCH** pitch control and hard sync. options
-   triangle waveform volume level
-   sawtooth waveform volume level
-  **PWM** pulse-width control
-   pulse waveform volume level

#### • Oscillator 2 pages:







-  **PHASE MOD** phase modulation level
-   overall volume level
-  **PITCH** pitch control and hard sync. options

-   triangle waveform volume level
-   sawtooth waveform volume level
-   square waveform volume level
-  **SUB** sub-oscillator waveform volume level







#### • Oscillator 3 pages:

-  **PHASE MOD** phase modulation level
-   overall volume level
-  **PITCH** pitch control
-   triangle waveform volume level
-   sawtooth waveform volume level
-  **PWM** pulse-width control
-   pulse waveform volume level





#### • Mixer pages:

-   noise source volume level and white/pink option
-   overall volume level from mixer and boost option
-   feedback/external audio input volume level



#### • Low-pass filter 1 pages:

-   cut-off frequency and input routing options
-   resonance amount and character option
-   output volume level and routing options

#### • High-pass filter pages:

-   cut-off frequency and input routing options
-   output volume level and routing options



- **Low-pass filter 2 pages:**

-  cut-off frequency and input routing options
-  resonance amount
-  output volume level and routing options

- **Output stage page:**



-  output volume level and clipping options



Use the 'page-lock' mode to allow rapid hands-on changes of parameter basic offsets such as sweeping filter cut-off, changing oscillator mix levels etc. without changing the active parameter page. Press the  **PAGE LOCK** button to toggle 'page-lock' on and off. When 'locked' the LED will flash next to the  **PAGE LOCK** button.

## 8.1 Parameter page display overview

Although controlling the sound in **MOTAS-6** may appear to be rather daunting at first given the number of parameter pages and the large number options on each page, once you have mastered operation of one of the parameter pages you will understand most of all the others as the basic operations are common to all pages.

So let's start by explaining operation of one of the parameter pages. Start by resetting the current patch by pressing  **COPY** and selecting 'reset patch'. Then turn the low-pass filter 1 cut-off control  to access that parameter page. You should now see something similar on the display to that shown in the figure below.

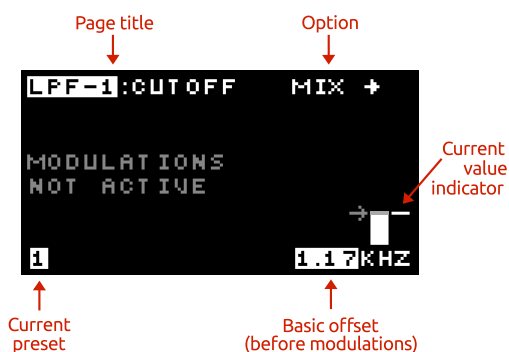





















### Page title





Each page has a 'destination' i.e. what aspect of the synthesizer it controls, and this is labelled at the top left of the display. In this case it is

**LPP-1 :CUTOFF** - the cut-off frequency of low-pass filter 1.

### Basic offset

Each parameter page has a basic offset level that can be adjusted using the rotary knobs  or rotary encoder  and   up and   down buttons . All of the modulation sources (see chapter 9) add (or subtract) from this offset to generate the final level. The rotary encoder ,   and   adjust the basic offset for the active page only when the basic offset is the active editable item (shown as flashing), otherwise they will control other parameters. However, the rotary knobs  always control the basic offset for their parameter page (except when 'value-lock' is enabled). Press and hold   or   to continuously change the offset in large steps. To reset the offset to its default value (zero for levels, standard pitch for pitch pages) press   and   simultaneously.



























Use the rotary knobs  for smooth fine control of the parameter page offset. Use the   and   buttons to jump set amounts in offset.



Push the rotary encoder  and turn at the same time to change values in larger steps for rapid sound adjustments.

### Page options

Some parameter pages have additional options unique to that page. Press   or   to see and change these options. Then press   and   to select the options (if there is more than one option) and the rotary encoder  to change the value. Press   and   simultaneously to jump to the first option. Press   or   again, or press   and   simultaneously to return to the main parameter page.

You can only change the page option when the active item is the basic offset (shown by flashing value at the bottom right-hand of the display) otherwise   and   control other options (more on this later!).



In the screenshot example shown above the option for the LPF-1 cut-off frequency page is the source of the audio input to the filter. In this case this input is set to 'mix'.

### Current values

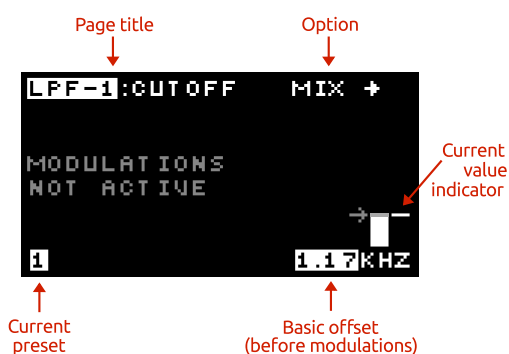

At the far right of the main parameter display a horizontal bar shows the current level of the destination signal in real time. The current value is the sum of the basic offset for the page with all the modulation signals (see chapter 9 for explanation of the modulation options).

If the controlling signal rises above the maximum of the destination then an 'up' arrow **+** is shown instead of the bar, and if the controlling signal falls below the minimum a 'down' arrow **-** is shown instead of the bar.

The horizontal arrow next to the solid vertical bar shows the current position of the rotary knob  ①.

**i** When the parameter page displays **MODULATIONS NOT ACTIVE** the current value will follow the basic offset, since all the modulations amounts are set to zero.

**i** The current value bar tries to follow the parameter page value in real-time. However, if the modulation is very fast this display will not be able to 'keep-up' and so you will only see a snapshot of the value at that point in time.

### Current preset

**MOTAS-6** has 5 preset patches. The current patch for editing is shown as a number in the bottom left corner (patch 1 in this case). In addition a corresponding preset ② LED will be brightly lit. When the arpeggiator or pattern sequencer changes the played preset patch the LED for that preset will be dimly lit, whilst the patch for editing will still be brightly lit. To change presets press one of the preset ② buttons.

## 9 Modulation

Modulation means changing parameter values from a modulation source. This could be a freely-changing modulation with time, such as from a low-frequency oscillator (LFO) that is not synchronised or modulation that is synchronised to the start of a key press, such as from an envelope generator (EG) triggered by a note-on event.







Conventional analogue synthesizers typically have a small number of LFOs and EGs (usually 1 or 2) that are used for modulation. In some cases the modulation sources have fixed destinations (such as a dedicated EG for output level) or can be set to only a limited number of destinations (such as filter cut-off frequency or pitch).

**MOTAS-6** is different – *every* parameter has its own dedicated LFO and dedicated EG in addition to dedicated modulation amount settings from velocity, pitch, 4 global LFOs, 4 global EGs and 4 external modulation sources (MIDI or CV input)! This powerful architecture allows complete freedom to modulate and control almost every aspect of the sound generation. You can freely set the modulation for every parameter separately if desired or have coupled modulation between parameters using the global modulation sources, if you wish.

Each parameter page allows you to set the levels and routings of the various parameters that determine the sound, but things get a lot more interesting once some modulation is used. Modulation allows creation of interesting sounds that change in character over time.

**i** Perhaps the most common 'modulation' used in synthesizing sounds (and often not really considered as modulation) is simply applying an envelope modulation to the output signal level. With this 'modulation' the volume increases once a key is pressed and decays away once the key is released. Without this modulation a constant sound volume would be heard whether or not a key was pressed, which would be used for a 'drone' sound patch.

Each and every parameter page has dedicated modulation control amounts from 9 sources:

	MIDI/CV note-on value
	MIDI/CV note velocity
	MIDI/CV global modulation M1
	MIDI/CV global modulation M2
	MIDI/CV global modulation M3
	MIDI/CV global modulation M4
<b>LFOx</b>	choice of global LFO x = 1–4
<b>LFO</b>	dedicated LFO for each parameter page
<b>EGx</b>	choice of global EG x = 1 – 4, or dedicated EG

The modulation amount can be zero (for no modulation), positive or negative. The actual modulation signal applied to the parameter page value is the product (i.e. multiplication) of the modulation amount and the modulation source signal at that point in time. All of the modulation signals are added together with the parameter page basic offset value to give the resulting value for the parameter page value.

**i** The modulations can be set to either a 'bipolar' or 'unipolar' response (except for the LFOs which are fixed in 'bipolar' response). Bipolar means that when the source is at its mid-value the modulation effect will be zero whilst in unipolar mode the effect is zero when the source is also at its zero value.

**i** The modulation amount displayed shows the modulation peak-to-peak maximum change. For example, if the modulation amount for LFO on the oscillator 1 pitch parameter page is set to 12.00s then the modulation of the pitch will vary over 12 semitones (1 octave) as the LFO waveform cycles from its minimum to maximum values.

### 9.1 MIDI / CV Modulations

There are 6 possible MIDI / CV modulation sources: MIDI note-on value (or CV pitch), MIDI velocity (or CV velocity) and 4 globally assigned MIDI or CV modulation sources.

The interface for all these modulations is the same. Each source has its own icon on the display running along the second row.



Each modulation source has two amount settings. The first (primary) sets the amount of the modulation signal to add or subtract to the parameter page basic offset e.g if set on the parameter page **LPF-1 : CUTOFF** it would directly increase or decrease the cut-off frequency of low-pass filter 1 as the modulation signal increases or decreases.

It is also possible to modulate the modulations. This is where the secondary destination and secondary amount is used.

From a patch parameter page press the modulation button desired (i.e. **NOTE**, **VELOCITY**, **M1**, **M2**, **M3** or **M4**). The modulation icon flashes to show it is in edit mode (i.e. one of **↓**, **<**, **⌂**, **⌂**, **⌂** or **⌂** flashes). Now turn the rotary encoder **5** or push the up **↑** or down **↓** buttons - the amount of this modulation source applied to the parameter page (the primary destination) is shown as a small vertical bar on the left-hand side above the modulation icon. Set positive values to increase the parameter page basic offset with increasing modulation signal or set negative values to decrease the parameter page basic offset with increasing modulation signal.

Press and hold **↑** or **↓** to continuously change the primary modulation amount in large steps. Press **↑** and **↓** simultaneously to reset the primary and secondary modulation amounts to zero.

**i** Positive modulation amounts are shown by a solid bar whilst negative amounts are shown with a hollow bar.

### Modulator secondary options

Now, with the modulation still in edit mode, press **←** or **→** to access the secondary options. The display show 3 choices: the secondary destination for this modulator, the amount of modulation to this destination and the choice between unipolar or bipolar operation. Use the **↑** and **↓** buttons to choose which parameter to edit and the rotary encoder **5** to change the values.

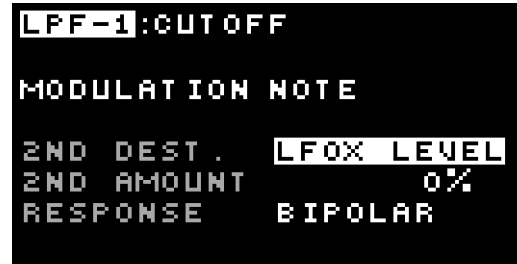

The secondary destination can be set to one of the following nine options:

- LFOX LEVEL**  
selected global LFO 1-4 level
- LFO FREQ**  
dedicated LFO frequency
- LFO LEVEL**  
dedicated LFO level
- EG TIME**  
dedicated EG time (affects the attack, decay and release times simultaneously)
- EG ATTACK**  
dedicated EG attack time
- EG DECAY**  
dedicated EG decay time
- EG SUSTAIN**  
dedicated EG sustain level
- EG RELEASE**  
dedicated EG release time
- EG LEVEL**  
EG level

### Response

**BIPOLAR** - in this mode when the modulation signal is at its mid-way value there is zero modulation effect.

**UNIPOLAR** - in this mode when the modulation signal is at zero the modulation effect is also zero.

**i** The page overview icon for the modulator will change depending whether the modulator is in unipolar or bipolar mode.

Press **↑** and **↓** simultaneously to always jump to the first option.

Press **←** or **→** again, or press **←** and **→** simultaneously to return to the main parameter page display.

On the main parameter page the amount of secondary modulation is shown as a small vertical bar on the right-hand side (next to the bar for the primary destination). The secondary modulation destination is shown as a number as listed above.

Details of each modulation source is given in the subsections below.



On the **MASTER PITCH** parameter page set a secondary destination of LFO amount (and set an appropriate secondary level amount) for a global modulation source which is assigned to the MIDI modulation wheel. Now the MIDI modulation wheel will control the depth of vibrato effect of the LFO.



On the **OUTPUT** parameter page set a secondary destination of **EG TIME** and a negative secondary level amount for the note modulation source. Set the output page to use the unique EG. Now higher pitch notes will have an EG envelope which processes faster such as is common for real-world stringed instruments.

### Note pitch modulation

On row 2 of the display, starting at the left-hand side is shown the note modulation setting, indicated by the  symbol. This controls how much the MIDI note-on signals or CV pitch voltage affect the page's destination (which in the example shown is the LPF-1 cut-off frequency) or how note-on signals affect other modulations for this page (if the secondary destination is used).

The higher the incoming MIDI note-on pitch or CV pitch voltage the higher the modulation signal.



The note pitch modulation signal is derived from the 'latest' (i.e. most recent) note currently being played, including the effects of portamento, but excluding pitch-bend signals.

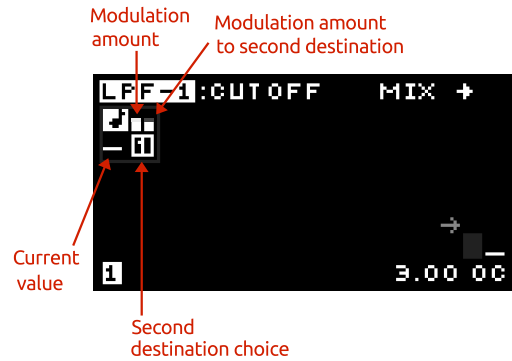

### Velocity modulation

To the right of the note modulation setting is shown the velocity modulation setting indicated by the  symbol. This section controls how note velocity signals affect the page's destination and levels or settings of other modulators for this page, in exactly the same way as for the note-on modulation.

The velocity is the source of this modulation signal. The harder the key is struck (on a touch sensitive MIDI keyboard) the higher this signal.

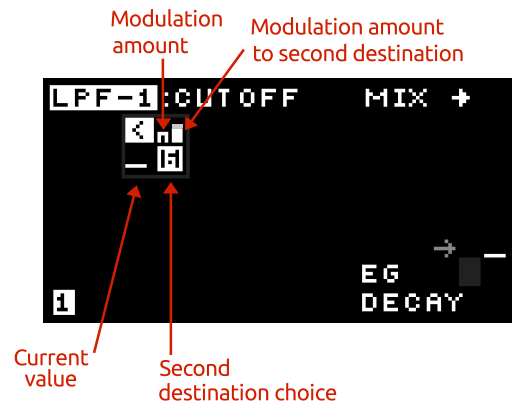

### Modulation sources M1, M2, M3 and M4

Each of these separate modulation sources can be assigned to any MIDI controller code e.g. modulation wheel, breath control, volume...or even pitch bend. Alternatively the modulation signals can come from the analogue CV/gate signal inputs. The source is stored with the patch but can be overridden by a global modulation source setting. See section 17.5 for how to setup these global modulation sources.

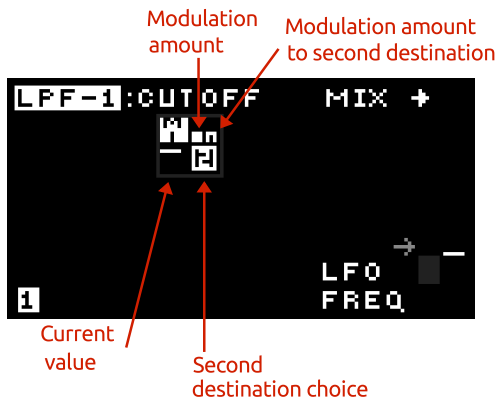

## 9.2 Low-Frequency Oscillator (LFO) waveforms

Both the global and dedicated LFOs (unique to each parameter page) have a wide choice of 50 waveforms. The first 33 waveforms are:

- sine **SIN**
- sine phase-shifted by 90 degrees **SIN-90**
- triangle **TRI**
- triangle phase-shifted by 90 degrees **TRI-90**
- square **SQUARE**
- pulse short **PULSE1**
- pulse medium **PULSE2**
- pulse long **PULSE3**
- ramp wave **RAMP**
- ramp phase-shifted by 90 degrees **RAMP90**
- ramp-hold **RMPHLD**
- 3-step **3-STEP**
- 4-step **4-STEP**
- sample-and-hold **S+H**
- sampled noise **NOISE**
- random triangle **RANTRI**
- pulse short reverse **PLSE1R**
- pulse medium reverse **PLSE2R**
- pulse long reverse **PLSE3R**
- ramp-hold reverse **RMPH-R**
- pulsed wave speeding up **BOUNCE**
- pulsed wave speeding up variant **BOING**
- pulsed wave slowing down **RETARD**
- damped sine **SINDEC**
- damped sine reversed **SININJ**

- very fast burst **BURST**
- fast burst **BURST2**
- sine + sine at twice frequency **SIN+2**
- sine + sine at three-times frequency **SIN+3**
- half sin and half triangle combo **SINTRI**
- half triangle, half constant combo **TRI/2**
- modulated sine **BEAT**
- modulated sine variation **BEAT2**

The remaining 17 waveforms are primarily aimed at pitch modulation of the oscillators to play tuned notes (but of course you don't have to do that!). They give the intended pitch with an LFO amount set to 12.00s

- chromatic increasing **CHROM**
- major chord triad **MAJOR**
- minor chord triad **MINOR**
- augmented chord triad **AUG**
- diminished chord triad **DIM**
- diminished 7th chord **DIM7**
- half-diminished seventh 7th chord **2DIM7**
- minor seventh 7th chord **MIN7**
- minor major 7th chord **MINMAJ**
- dominant 7th chord **DOM7**
- major seventh 7th chord **MAJ7**
- augmented seventh 7th chord **AUG7**
- aug. major seventh 7th chord **AMAJ7**
- mini sequence 1 **SEQ1**
- mini sequence 2 **SEQ2**
- mini sequence 3 **SEQ3**
- mini sequence 4 **SEQ4**

## 9.3 Global Low-Frequency Oscillators (LFOx)

The LFOx modulation source for each parameter page is one from a choice of four LFOs which are globally available to the current patch. This allows exactly the same LFO modulation frequency and waveform to be applied to several parameter page destinations. This is in contrast to the unique LFO for each parameter page. Although the LFOx waveform and frequency is global the level of modulation is unique to each page.

On the fourth row down on the display, on the left hand side the settings for LFOx are shown.

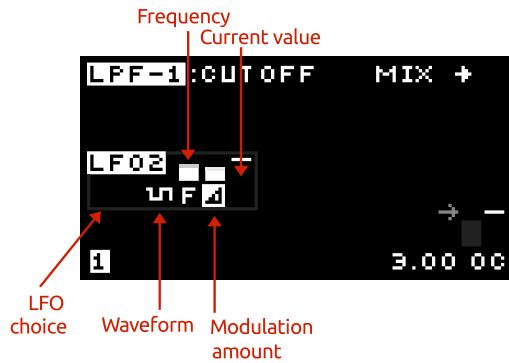

The global LFOs are useful when the same LFO modulation signal is desired applied to more than one destination, e.g. a tremolo modulation (volume modulation) at the same frequency as vibrato (pitch modulation). Note that although the LFOs are global, the level applied to each destination is independent.

To change the LFO waveform press for **LFO X** then use the rotary encoder or press or , to change the waveform. The current setting will be shown on the display. Press and hold or to rapidly change the waveform. Press and simultaneously to reset the waveform to a sine wave.

See section 9.2 for a list of the available waveforms. For example when the waveform is a sine wave the symbol will be shown.



If you change the parameters for the global LFO on a parameter page (except for the level amount) you will change the parameters of that LFO for all the parameter pages that use that LFO – because it is global. If you want to have a unique LFO for parameter page then either use an unused global LFO or use the dedicated LFO.

### LFO frequency

Here the frequency of **LFO X** can be modified. To change the frequency press for **LFO X** and then use rotary encoder or / .

In non pitch-tracking mode the frequency can be set from 0.001Hz – 452Hz (time period from 1000s to 2.2 ms). Press and simultaneously to reset the frequency to 1Hz. The icon displayed is **F**.

In pitch-tracking mode the frequency can be offset from -40.96 semitones to + 40.96 semitones in steps of 2 cents. Press and simultaneously to reset to 0. The icon displayed is **H** or **F**.

Settings below the minimums stated above cause the LFO to synchronise to the clock source (note that you must use the rotary encoder to enter this mode). See section 17.3 for details on the clock source. When set to synchronise to the clock the display will show a metronome indicator and the LFO period value (down to as fast as 32 triplet). The icon displayed is **E** in this mode.

### Modulation level

To control the level of LFOx on the parameter page destination press for **LFO X**. Press and simultaneously to reset the level to zero.



Use a negative modulation amount to have an inverted modulation waveform.

### Global LFO options

With an LFOx parameter active (i.e. from either for **LFO X**, or ) press or to access further options.

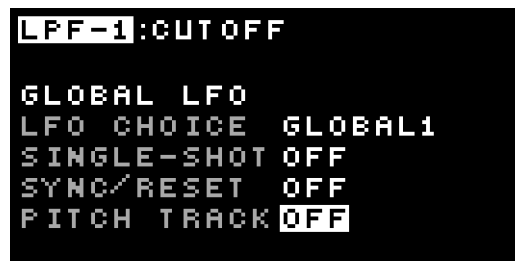

Use and to choose which LFO option to edit and the rotary encoder to change the values. There are 4 options:

### Choice of global LFO 1-4

Choose from one of the 4 global LFOs to assign to this parameter page: **GLOBAL1**, **GLOBAL2**, **GLOBAL3** or **GLOBAL4**.

## LFO single-shot

- **OFF** the LFO runs continuously.
- **ON** the LFO will do one cycle of oscillation (however this only is active when the LFO is also set to a sync. mode, see below).

## LFO sync/reset options

- **OFF** the LFO is not reset on note-on or gate signals.
- **FIRST NOTE** the LFO resets on the *first* note-on or gate signal.
- **ALL NOTES** the LFO resets on *all* note-on or gate signals.

## LFO pitch track options

- **F/S** **OFF** the LFO runs without tracking pitch.
- **N** **NOTE** the LFO will track the last played note including pitch bend and global tuning and offset.
- **P** **PITCH** the LFO will track as per **NOTE** and also track the **MASTER PITCH** page.

Press **↑** and **↓** simultaneously to always jump to the first option.

Press **←** or **→** again, or press **←** and **→** simultaneously to return to the main parameter page display.



Try applying the **▬** or **▬** stepped waves to modulate the oscillator pitch and the oscillator will play an arpeggio where the notes heard depend on the level control. Try levels of 5, 7 or 9 semitones. Use a positive level to play 'up' and negative level to play 'down'.



Use pitch-tracking to apply a range of AM and FM effects (depending where the LFO is applied). Offset the pitch-tracking frequency to give characteristic noisy/complex tones. Since the LFOs cannot run at high audio rates (due to hardware limitations) digital aliasing artifacts will be heard when at higher frequencies, especially if the LFO waveform is not a sine wave. Consider this an audio effect rather than an error!



When the LFO is synced to note-on or arpeggiator then you can choose the standard or phase-shifted waves depending whether you want the wave to start from the peak or mid-range value at the sync event.

## 9.4 Dedicated Low-Frequency Oscillators (LFO)

This LFO is unique to each parameter page. In other words, every parameter page has its own unique LFO. This allows highly complex LFO modulations to each characteristic of the patch.

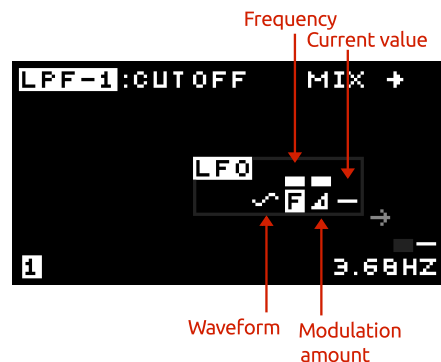

To change the LFO waveform press the **WAVEFORM** for **LFO** then use the rotary encoder **○**, or press **↑** or **↓**, to change the waveform. The current setting will be shown on the display. Press **↑** and **↓** simultaneously to reset the waveform to a sine wave. See section 9.2 for a list of the available waveforms.

### LFO frequency

Here the frequency of the dedicated LFO can be modified. To change the frequency press **FREQUENCY** for **LFO** and then use rotary encoder **○** or **↑** / **↓**.

In non pitch-tracking mode the frequency can be set from 0.001Hz – 452Hz (time period from 1000s to 2.2 ms). Press and simultaneously to reset the frequency to 1Hz. The icon displayed is **F**.

In pitch-tracking mode the frequency can be offset from -40.96 semitones to + 40.96 semitones in steps of 2 cents. Press and simultaneously to reset to 0. The icon displayed is **N** or **P**.

Note that the dedicated LFOs cannot be synchronised to the clock.

### LFO modulation level

To control the strength of the dedicated LFO on the parameter page destination press for **LFO** . Press and simultaneously to reset the level to zero.

### Dedicated LFO options

With an LFO parameter active (i.e. from either , **FREQUENCY** or ) press the or button to access the more advanced options.

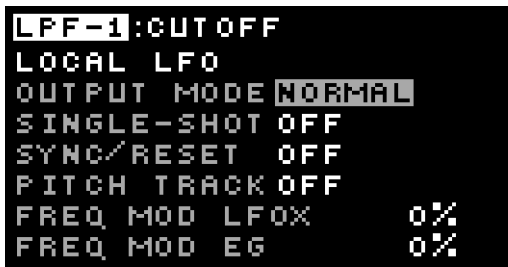

Use the and buttons to choose which LFO option to edit and the rotary encoder to change the values. There are 6 options:

### Output mode

- NORMAL** LFO output level is not modulated.
- MOD EG** LFO level is modulated (multiplied) by the active EG internal signal.
- MOD LFOX** LFO amount is modulated (multiplied) by the active LFOx internal signal.



Modulate the **MASTER PITCH** with the dedicated LFO and use the modulation option to create a vibrato effect that is delayed and builds in amplitude as a key is pressed, according to the EG setting for that parameter page.

### LFO single-shot

- OFF** the LFO runs continuously.
- ON** the LFO will do one cycle of oscillation (however this only is active when the LFO is also set a sync. mode, see below).

### LFO sync/reset options

- OFF** the LFO is not reset on note-on or gate signals.
- FIRST NOTE** the LFO resets on the *first* note-on or gate signal.
- ALL NOTES** the LFO resets on *all* note-on or gate signals.

### LFO pitch track options

- F** **OFF** the LFO runs freely.
- N** **NOTE** the LFO will track the last played note including pitch bend and global tuning and offset.
- P** **PITCH** the LFO will track as per **NOTE** and also track the **MASTER PITCH** page.

### LFO frequency modulation

The active global LFO and EG for this parameter page can modulate the dedicated LFO frequency. Set the amounts here under **FREQ MOD LFOX** and **FREQ MOD EG**. The amount is shown in % or in cents/semitones when the LFO is set to track note or pitch.



Try setting the dedicated LFO to modulate the phase modulation amount (oscillators 2 or 3) with LFO frequency modulation from a global LFO and/or the EG for some really complex sound effects!

Press the or button again to return to the main parameter page display.

## 9.5 Envelope Generators (EG)

Each parameter page can be assigned either a dedicated local EG (labelled on the screen as **EG**) or one of four global EGs (labelled on the screen as **EG1**, **EG2**, **EG3** and **EG4**).

The EG creates a signal that varies over time. It consists of 5 phases. The first phase 'delay' is started by a MIDI note-on or gate trigger event. The final release phase starts by a MIDI note-off or gate off event.

- D** delay – sets the delay in time before the attack phase starts (0 to 2.43 seconds).
- A** attack – sets the time for the envelope to rise after the delay phase (1 ms to 34.6 seconds).
- D** decay – sets the time for the envelope to fall after reaching the maximum level in the attack phase (1 ms to 34.6 seconds).
- S** sustain – sets the level to which the envelope falls at the end of the decay phase.
- R** release – sets the time that the envelope falls from the sustain level (1 ms to 34.6 seconds).

Press and simultaneously to reset the values to defaults.

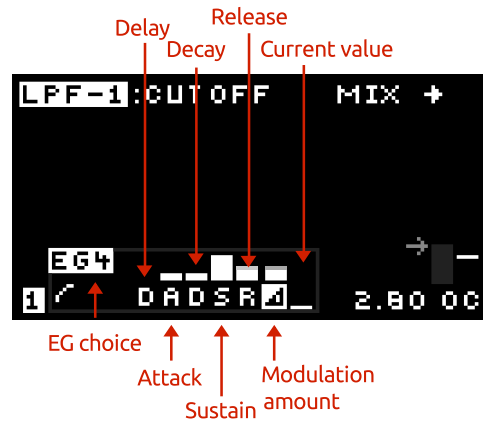
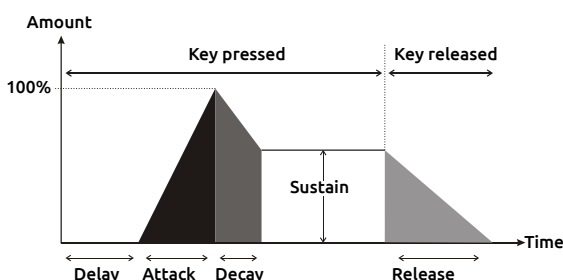

### Modulation level

To control the strength of the active EG on the parameter page destination press and use the rotary encoder or and . Press and simultaneously to reset the level to zero.

### EG options

With an EG parameter active (i.e. from either or ), press , , , or ) press or to access the more advanced options.

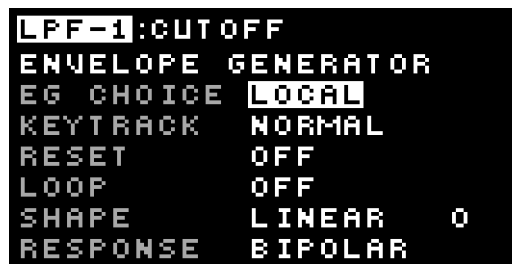

Use and to choose which EG option to edit and the rotary encoder to change the values. There are 6 options.

### EG Choice

Choose from the dedicated local EG or one of the 4 global EGs to assign to this parameter page:

**LOCAL**, **GLOBAL1** - **GLOBAL4**.

## Keytrack

- **NORMAL** EG triggers on *first* note-on event, release phase starts when all notes are released.
- 1 **1ST NOTE** EG triggers on *1st* note-on event, release phase starts when that note is released.
- 2 **2ND NOTE** EG triggers on *2nd* note-on event (when multiple keys held down), release phase starts when that note is released.
- 3 **3RD NOTE** EG triggers on *3rd* note-on event (when multiple keys held down), release phase starts when that note is released.
- E **EVERY** EG triggers on *every* note-on event, release phase starts when all notes are released.
- H **HIGHEST** EG triggers on *highest* note-on event, release phase starts when all notes are released.
- M **MIDDLE** EG triggers on *middle* note-on event, release phase starts when all notes are released.
- L **LOWEST** EG triggers on *lowest* note-on event, release phase starts when all notes are released.

Additionally, the behaviour of EG re-triggering on note-off events is determined by a global patch setting for all EGs (see section 17.1). All EGs can be set to never re-trigger on note-off events, or can re-trigger under certain conditions.

## Reset

- **OFF** when re-triggered by a note-on or gate event the EG will start the delay phase from the level the EG was at before the event.
- ↓ **ON** when re-triggered by a note-on or gate event the EG will reset to zero.



Use the EG reset feature on percussion sounds where you want the EG cycle to always restart from zero.

## Loop

- **OFF** the EG will progress through all the phases.
- ↳ **ON** the EG will move to the delay phase after the decay phase, repeatedly, in a loop.



Use the EG loop feature to use it as a sort of LFO where the rise and fall time of the waveform is set by the attack and decay times.

## Shape

The shape of the EG curve can be adjusted over a wide range.

- ↖ **LOG-F** very fast curve transitioning to very slow (settings 40 ... 64).
- ↖ **LOG** fast curve transitioning to slow (settings 15 ... 39).
- ↗ **LINEAR** more uniform response over time (settings -14 ... 14).
- ↘ **EXP** slow curve transitioning to fast (settings -39 ... -15).
- ↘ **EXP-F** very slow curve transitioning to very fast (settings -64 ... -40).



Adjusting the EG response shape can be especially effective on short-duration sounds such as percussion.

## Response

**BIPOLAR** – in this mode when the EG signal is at its mid-way value there is zero modulation effect.

**UNIPOLAR** – in this mode when the EG signal is at zero the modulation effect is also zero (this is the more conventional mode for an EG).



Press and simultaneously to always jump to the first option. Press or again, or press and simultaneously to return to the main parameter page.





EG keytrack mode **H HIGHEST** means that whenever there is a new 'highest' note played the EG will trigger. This means that the EG will trigger when a first note is played (as this is a new 'highest' note). The EG will then re-trigger if a second note is played whilst the first is held down, as long as the second note is higher. If a third note is played but lower in pitch, then the EG will not react. If the patch setting **TRACK NOTE-OFF** is set to **F+EG** then if the second note is released the EG will re-trigger as there is now another 'new' highest note (either the first or the third, depending which notes were played!). EG trigger modes **M** and **L** work in similar ways to **H**.



## 10 Parameter pages - in depth

This chapter describes each parameter page in detail. The settings on each parameter page control the sound **MOTAS-6** makes. To access a particular parameter page turn the appropriate rotary knob  . The active parameter page is shown by the adjacent flashing LED.



Use the 'value lock' feature to allow changing of the active parameter page without changing the sound parameters. Press  **VALUE LOCK** to toggle 'value-lock' on and off. When 'locked' the LED will flash next to the  **VALUE LOCK** button.

### 10.1 Master Pitch

#### MASTER PITCH

##### MASTER PITCH

This parameter page controls the pitch of the three oscillators. Although each oscillator has its own pitch control parameter page you can easily apply offset and modulation to all the oscillators together using this parameter page.



Set up a vibrato effect by applying a fast sine wave from an LFO to this page. This will pitch shift all three of the oscillators at the same time.



Pitch-shift all 3 oscillators up an octave by applying an offset of +12 semi-tones to this page.



Internally the analogue pitch control signals for each oscillator are generated from the output of this parameter page added to the dedicated pitch parameter page outputs for each oscillator.

### 10.2 Oscillator 1

Oscillator 1 has triangle, sawtooth and variable pulse-width waveforms available. It can be hard-synced to oscillators 2 and 3.

#### OSC-1 LEVEL



This parameter page sets the overall volume level of the waveforms from oscillator 1 into the mixer.

Although each waveform from oscillator 1 has its own level parameter page you can easily apply offset and modulation to the overall volume level of oscillator 1 from this parameter page.





If the overall level is zero from the oscillator level page then no output from that oscillator will be input to the mixer, even if the individual wave outputs (e.g. triangle, sawtooth) are set to non-zero.







High level settings can cause the internal analogue circuitry to distort and clip the waveforms - use this feature to add further sonic interest to the sound. For a cleaner sound use low to moderate levels. You can use the oscilloscope feature to monitor the waveforms to see if they are clipping.

#### OSC-1 PITCH

##### PITCH

This parameter page sets the pitch (frequency) of oscillator 1. The basic offset settings displayed here are relative offsets. An offset of zero means that the oscillator will play in-tune with the incoming MIDI note or CV signal (for calibrated CV signals). For small offsets the display shows pitch in cents  which is 1/100 of a semi-tone. Above 99 cents the display shows the pitch in semi-tones .

#### Oscillator options

View and edit the additional options by pressing   or   when the active item is the basic offset.

#### Note track

When multiple notes are held down at the same time the pitch of oscillator 1 can be set in a number of different ways. There are the following 7 note track options:

- LST** **LAST** pitch set to the *last* note on.
- 1** **1ST** pitch set to the *1st* or earliest note on.
- 2** **2ND** pitch set to the *2nd* note on
- 3** **3RD** pitch set to the *3rd* note on.
- HI** **HIGHEST** pitch set to the *highest* note on.
- MED** **MIDDLE** pitch set to the *middle* note on. (If fewer than 3 notes are on then pitch is set to the highest note on).
- LOW** **LOWEST** pitch set to the *lowest* note on.

Additionally, the behaviour of the pitch tracking on note-off events is determined by a global patch setting **TRACK NOTE-OFF** for all oscillators. See section 17.1 for more details. In some modes, with this feature turned on, the pitch will change to track the remaining notes pressed as others are released.



### Hard sync.

Oscillator 1 has 4 hard-sync options.

- S: OFF** **OFF** sync is off
- S: 2** **OSC 2** hard-sync to oscillator 2
- S: 3** **OSC 3** hard-sync to oscillator 3
- S: 2+3** **OSC 2+3** hard-sync to oscillators 2 and 3

**i** Hard-sync means that the oscillator core re-sets whenever the oscillator it is synced to resets – this causes the oscillator to track in pitch although because the reset could happen part-way along the waveform interesting timbral effects can be obtained.



**MOTAS-6** can play paraphonically – you can play up to 3-note chords where each note of the chord is generated by each oscillator. The oscillators of course still share the same filter and output settings so this is paraphonic not polyphonic operation. Setup **1ST** for **OSC-1: PITCH**, **2ND** for **OSC-2: PITCH** and **3RD** for **OSC-3: PITCH**. Also, setup **OSC-1: LEVEL** to have an envelope that is triggered only by the 1st note, **OSC-2: LEVEL** with an envelope triggered by the 2nd note and **OSC-3: LEVEL** with an envelope triggered by the 3rd note. As a variation, use the **HI**, **MED** and **LOW** tracking modes for each of the oscillators so that when only one note is played all 3 oscillators play in unison but as multiple notes are held each oscillator will play a different pitch forming a chord! With this setup you can use a standard envelope that responds to all notes.



For a more interesting audible effect set the oscillator with hard-sync to a higher pitch than the oscillator it is synced to.



Hard-sync oscillator 1 to oscillator 2 and use phase-modulation on oscillator 2. Then, vary oscillator 1 pitch with modulation. The effect will be that the oscillator 2 triangle and sawtooth waveforms distort strongly but in a (possibly musical...) pitch-controlled way.

### **OSC-1: TRIANGLE**



This parameter page sets the volume level of the triangle wave output of oscillator 1.

The triangle wave has a linear rising and falling shape and has a low level of harmonics (principally odd harmonics) so is closest to a pure tone and so is useful for generating flute-like tones, pure bass notes and for adding into the mix to add stronger fundamental tones.

## OSC-1 : SAWTOOTH



This parameter page sets the volume level of the sawtooth wave output of oscillator 1.

The sawtooth wave has a rising and then abruptly falling shape giving a tone very rich in harmonics (odd and even). Use for many sounds including strings, with appropriate filtering.

## OSC-1 : PULSE MOD.



This parameter page sets the pulse-width (or duty cycle) of the pulse wave of oscillator 1.

With very short or very long widths the tone is very raspy with many harmonics but low overall signal strength. At a mid setting the tone is that of a square wave (odd harmonics only) with the maximum signal strength.



To create a classic PWM (pulse width modulation) phasing effect apply a slow sine-wave LFO (< 1 Hz) to modulate the output of this page.

## OSC-1 : PULSE LEVEL



This page sets the volume level of the pulse wave for oscillator 1. This wave is a rectangular wave with a pulse width (or duty cycle) determined from the

**OSC-1 : PULSE MOD.** page.

### 10.3 Oscillator 2

Oscillator 2 has triangle, sawtooth, square and sub-square waveforms available. It can be hard-synced to oscillators 1 and 3. Its triangle and sawtooth waveforms can be phase-modulation from oscillator 1.

## OSC-2 : PHASE MOD



This parameter page sets the phase modulation depth for oscillator 2. The triangle and sawtooth waveforms from oscillator 2 are phase-modulated from the internal triangle waveform of oscillator 1.



Phase-modulation is a form of waveform distortion where the phase of the waveform is changed over time. It is very similar to frequency modulation but does not have the problems of pitch stability that can occur with frequency modulation.

## OSC-2 LEVEL



This parameter page sets the overall volume level of the waveforms from oscillator 2 into the mixer.

Although each waveform from oscillator 2 has its own level parameter page you can easily apply offset and modulation to the overall volume level of oscillator 2 from this parameter page.



Setup a global modulation source such as the MIDI modulation wheel on this parameter page with a positive modulation amount. When that controller value increases the volume level of oscillator 2 going to the mixer will then increase. Set the controller value to minimum and then adjust the parameter page basic offset (with the rotary knobs ① or rotary encoder ② and ③) up and ④ down buttons ⑤) to set the level desired.

## OSC-2 : PITCH







To play guitar-style lead solo sounds try using pitch tracking option **HI** for **OSC-1,2,3 : PITCH** and set the patch global setup **TRACK NOTE-OFF** to **PITCH** or **P+EG** so that the pitch will track note-off events (so that as a higher key is released the pitch jumps to the new 'highest' pitch of the lower note still pressed). Hold a low note down and tap higher notes on and off to play the riff.

This parameter page sets the pitch (frequency) of oscillator 2. The basic offset settings displayed here are relative offsets. An offset of zero means that the oscillator will play in-tune with the incoming MIDI note or CV signal (for calibrated CV signals). For small offsets the display shows

pitch in cents **C** which is 1/100 of a semi-tone. Above 99 cents the display shows the pitch in semi-tones **S**.

### Oscillator options

View and edit the additional options by pressing   or   when the active item is the basic offset.

### Note track

When multiple notes are held down at the same time the pitch of oscillator 2 can be set in a number of different ways. There are the following 7 note track options:

- LST** **LAST** pitch set to the *last* note on.
- 1** **1ST** pitch set to the *1st* or earliest note on.
- 2** **2ND** pitch set to the *2nd* note on
- 3** **3RD** pitch set to the *3rd* note on.
- HI** **HIGHEST** pitch set to the *highest* note on.
- MED** **MIDDLE** pitch set to the *middle* note on. (If fewer than 3 notes are on then pitch is set to the highest note on).
- LOW** **LOWEST** pitch set to the *lowest* note on.

Additionally, the behaviour of the pitch tracking on note-off events is determined by a global patch setting **TRACK NOTE-OFF** for all oscillators. See section 17.1 for more details. In some modes, with this feature turned on, the pitch will change to track the remaining notes pressed as others are released.

### Hard sync.

Oscillator 2 has 4 hard-sync options:

- S: OFF** **OFF** sync is off
- S: 1** **OSC 1** hard-sync to oscillator 1
- S: 3** **OSC 3** hard-sync to oscillator 3
- S: 1+3** **OSC 1+3** hard-sync to oscillators 1 and 3



To make an oscillator have a fixed pitch regardless of the incoming MIDI note value set a note modulation amount of -12 semi-tones.

### OSC-2 : TRIANGLE



This parameter page sets the volume level of the triangle wave output of oscillator 2.

This waveform can be phase-modulated to distort the waveform from a pure triangle.

### OSC-2 : SAWTOOTH



This parameter page sets the volume level of the sawtooth wave output of oscillator 2.

This waveform can be phase-modulated to distort the waveform from a pure sawtooth.

### OSC-2 : SQUARE



This parameter page sets the level of the square wave going to oscillator 2 mix.



The square wave has a hollow tone and has strong odd harmonics. Use for organ sounds and for strong bass notes.

### OSC-2 : SUB-OSC



This parameter page sets the level of the sub-oscillator wave going to oscillator 2 mix.

The sub-wave is a square wave at half the frequency of the other oscillator 2 waveforms (one octave lower). Adding this wave to the mix adds a deep sub-octave sound, especially useful for bass tones.



adding some sub-wave to the mix is a quick way to strengthen the bass-end of the sound.

## 10.4 Oscillator 3

Oscillator 3 has triangle, sawtooth and variable-width pulse waveforms available. It's triangle, sawtooth and pulse waveforms can be phase-modulation from oscillator 1 or 2.

### OSC-3 : PHASE MOD



This parameter page sets the phase modulation depth for oscillator 3. The triangle, sawtooth and pulse waveforms from oscillator 3 can be phase-modulated from the internal triangle wave of oscillator 1 or 2.

View and edit the additional options by pressing ← or → when the active item is the basic offset.

**OSC 1** phase-modulation from oscillator 1.  
**OSC 2** phase-modulation from oscillator 2.



Use phase-modulation to create FM-style sounds. Use an EG to modulate the phase-modulation amount to create sharp attack sounds that decay to softer undistorted sounds.

### OSC-3 LEVEL



This parameter page sets the overall volume level of the waveforms from oscillator 3 into the mixer.

Although each waveform from oscillator 3 has its own level parameter page you can easily apply offset and modulation to the overall volume level of oscillator 3 from this parameter page.

### OSC-3 : PITCH



This parameter page sets the pitch (frequency) of oscillator 3. The basic offset settings displayed here are relative offsets. An offset of zero means that the oscillator will play in-tune with the incoming MIDI note or CV signal (for calibrated CV signals). For small offsets the display shows pitch in cents which is 1/100 of a semi-tone. Above 99 cents the display shows the pitch in semi-tones .

### Oscillator options

View and edit the additional options by pressing ← or → when the active item is the basic offset.

### Note track

When multiple notes are held down at the same time the pitch of oscillator 3 can be set in a number of different ways. There are the following 7 note track options:

**LST** **LAST** pitch set to the *last* note on.  
**1** **1ST** pitch set to the *1st* or earliest note on.  
**2** **2ND** pitch set to the *2nd* note on  
**3** **3RD** pitch set to the *3rd* note on.  
**HI** **HIGHEST** pitch set to the *highest* note on.  
**MED** **MIDDLE** pitch set to the *middle* note on. (If fewer than 3 notes are on then pitch is set to the highest note on).  
**LOW** **LOWEST** pitch set to the *lowest* note on.

Additionally, the behaviour of the pitch tracking on note-off events is determined by a global patch setting **TRACK NOTE-OFF** for all oscillators. See section 17.1 for more details. In some modes, with this feature turned on, the pitch will change to track the remaining notes pressed as others are released.



Set each of the three oscillators in a patch to slightly different pitches to create a thick, very rich analogue sound.



Since **MOTAS-6** has real analogue oscillators even at a setting of zero pitch offset the oscillators will still drift in tune slightly producing a naturally rich sound. To lock the oscillator pitches use the hard-sync feature.

### OSC-3 : TRIANGLE



This parameter page sets the volume level of the triangle wave output of oscillator 3.

This waveform can be phase-modulated to distort the waveform from a pure triangle.

### OSC-3 : SAWTOOTH



This parameter page sets the volume level of the sawtooth wave output of oscillator 3.

This waveform can be phase-modulated to distort the waveform from a pure sawtooth.

## OSC-3 : PULSE MOD.



This parameter page sets the pulse-width (or duty cycle) of the pulse wave of oscillator 3.

## OSC-3 : PULSE LEVEL



This page sets the volume level of the pulse wave for oscillator 3. This wave is a rectangular wave with a pulse width (or duty cycle) determined from the

**OSC-3 : PULSE MOD.** page.

This waveform can be phase-modulated to distort the waveform so that the pulse-width varies with the phase-modulation (i.e. at audio frequencies).

## 10.5 Mixer section

The mixer combines the audio signals from the 3 oscillators together with the noise source and feedback/external input signals.

## MIXER : NOISE



The noise generator can be set to pink or white noise main output. This parameter page sets the output level to the main mix.

### Noise options

View and edit the additional options by pressing

or when the active item is the basic offset.

**WHITE** white noise.

**PINK** pink noise (filtered white noise, -3dB per octave).



Use an EG to modulate the noise level to give a short burst of noise at the start of each note press to simulate percussive sounds.



white noise has a uniform energy density with frequency. To the ear this sounds very 'hissy' because for each rising octave of pitch there is a doubling of frequency, so most of the energy is present at the higher octaves. Pink noise has a frequency spectrum such that the energy density is inversely proportional to the frequency. To the ear this sounds more uniform since although for each octave of pitch there is a doubling of frequency the density of the pink noise is reduced to compensate.

## MIXER : FB/EXTERNAL



When no audio connector is plugged into then an internal audio connection is made from the audio output (after the 'output' stage but before the final volume control stage) to the mixer. This parameter page sets the level of that signal into the mixer. This internal 'feedback' feature allows additional feedback effects to be generated.

To process an external mono audio signal (instead of the internal feedback) plug your external audio source into the rear of the unit on the 'external in' socket . This parameter page sets the level of that signal into the mixer. This allows you to process external audio through the filters, alongside the internal audio sources.



When the feedback connection is active the feedback effect will vary with the output level, and will change according to the clipping options in the output stage.



Using the internal feedback feature setup a fast attack and decay EG with low sustain level to modulate the level of this parameter page. This might give an initially heavily distorted sound that decays to something cleaner.



When using the internal feedback be careful as self-oscillation can occur (when the gain around the loop from the mixer, through the filters and to the output and back in again is too high)- so be careful of your speakers/hearing!



The phase of the internal feedback signal is in-phase with the oscillator outputs. This means that you can increase the bass-end of the signal using the feedback feature even when the low pass filters are set at high resonance (which would normally attenuate the bass-end).

## MIXER



This parameter page sets the total level of the outputs of oscillators 1, 2 and 3 together with the noise and external input signals.

### Mixer options

View and edit the additional options by pressing or when the active item is the basic offset.

**NORMAL**

normal gain.

**BOOST**

gain boost. Extra gain is applied before the audio signal reaches the filter stages. This can be useful to overdrive the filters to create a harsher sound.

## 10.6 Low-pass filter 1

A key part in subtractive synthesis is the use of filters to shape the harmonic content to give a rich variety of sounds. This filter is a very powerful low-pass filter with up to 6-pole roll-off (-36 dB per octave). It has adjustable resonance (or feedback) amount, with three options for the source of the feedback. The output can be tapped off from any of the poles (from zero to the 6th pole).

### LPF-1 : CUTOFF



The cut-off frequency is controlled with this parameter page. The lower the setting the more filtering will be applied to the input signal. At higher settings more of the input harmonics are passed through with corresponding brighter sound.

### LPF-1 input options

This parameter page also allows control of which audio signal is input to the filter.

View and edit the additional options by pressing

or when the active item is the basic offset.

**MIX**

**MIX** the main mix (normal setting).

**LPF2**

**LPF2** low-pass filter 2.

**HPF**

**HPF** the high-pass filter.

**NOISE**

**NOISE** the noise source.

**PULS1**

**PULSE 1** pulse waveform from oscillator 1.

**SAW2**

**SAWTOOTH 2** sawtooth waveform from oscillator 2.

**TRI3**

**TRIANGLE 3** triangle waveform from oscillator 3.

**SUB2**

**SUB 2** sub-square waveform from oscillator 2.

### LPF-1 : RESONANCE



Resonance amount is controlled from this parameter page. A portion of the output of the filter is fed-back to the input causing a resonance peak in the output at high levels, changing the characteristic of the sound passing through the filter. At very high settings the filter may self-oscillate and make noise even without any input signal.

### LPF-1 resonance source

View and edit the additional options by pressing

or when the active item is the basic offset.

The analogue signal from where the feedback signal is routed can be chosen from the following 3 options:

**POLE-4**

pole-4 output (-24 dB roll-off per octave).

**POLE-6**

pole-6 output (-36 dB roll-off per octave).

**HPF**

high-pass filter output.

Each of these sound different - the 4-pole output gives a higher resonant frequency (for the same filter cut-off frequency) and tends to attenuate the signals below the resonance frequency more than the 6-pole setting.



The filter will self-oscillate at offset values around 70 (assuming no modulations are present)

## LPF-1 : OUTPUT



This parameter page sets the level of the audio signal passing into the final mixer stage. Note that when chaining the output of this filter to the input of another filter this setting is not relevant - it only sets the level to the output stage.

### LPF-1 output pole

View and edit the additional options by pressing or when the active item is the basic offset.

Low-pass filter 1 has separate filtering stages and the one selected for the final output can be selected from the following options:

<b>BYPASS</b>	output directly from the input
<b>POLE-1</b>	pole-1 (-6 dB per octave).
<b>POLE-2</b>	pole-2 (-12 dB per octave).
<b>POLE-3</b>	pole-3 (-18 dB per octave).
<b>POLE-4</b>	pole-4 (-24 dB per octave).
<b>POLE-5</b>	pole-5 (-30 dB per octave).
<b>POLE-6</b>	pole-6 (-36 dB per octave).

At the pole-6 (-36dB roll-off per octave) setting the roll-off of the filter is at it's most steep and so the harmonics of the sound above the cut-off frequency are most strongly attenuated. Most traditional analogue synthesizers only have a maximum roll-off of -24dB (i.e. 4 poles).



Use the -36dB setting for the darkest, most filtered bass sounds. Use other settings for brighter sounds.

## 10.7 High-pass filter

The high-pass filter is a 2-pole design (-12dB/octave). The sound is left brighter, lacking in bass as the cut-off frequency is increased.

### HPF : CUTOFF



This parameter page sets the cut-off frequency. The higher the setting the more of the input signal at low frequencies is attenuated.

### HPF input

This parameter page also allows control of which audio signal is input to the high-pass filter.

View and edit the additional options by pressing

or when the active item is the basic offset.

Choose the input signal to the filter from the following options:

<b>MIX</b>	output of the main mix (normal setting).
<b>POLE-1</b>	low-pass filter 1 pole 1.
<b>POLE-2</b>	low-pass filter 1 pole 2.
<b>POLE-4</b>	low-pass filter 1 pole 4.
<b>POLE-5</b>	low-pass filter 1 pole 5.
<b>POLE-6</b>	low-pass filter 1 pole 6.
<b>NOISE</b>	the noise source.
<b>LPF2</b>	low-pass filter 2.



Use this filter in series with the low-pass filters to produce a band-pass filter effect. For example, set the output levels of the low-pass filters to zero, and set the input of this filter to LPF2. Now the sound from the mixer will pass first through LPF2 and then into this high-pass filter, creating the band-pass effect.

## HPF : OUTPUT



This parameter page sets the level of the audio signal passing into the final mixer stage. Note that when chaining the output of this filter to the input of another filter this setting is not relevant - it only sets the level to the final mixer.

## 10.8 Low-pass filter 2

This filter is similar in design to that from a certain famous metallic grey bassline synthesizer from the early 80s ...It has a characteristic sound all of it's own.

### LPF-2 : CUTOFF



The cut-off frequency is controlled with this parameter page. The lower the setting the more filtering will be applied to the input signal. At higher settings more of the input harmonics are passed through with corresponding brighter sound.

### LPF-2 input options

This parameter page also allows control of which audio signal is input to the filter.



View and edit the additional options by pressing ← or → when the active item is the basic offset.

- MIX** output of the main mix (normal setting).
- POLE-1** low-pass filter 1 pole 1.
- POLE-2** low-pass filter 1 pole 2.
- POLE-4** low-pass filter 1 pole 4.
- POLE-5** low-pass filter 1 pole 5.
- POLE-6** low-pass filter 1 pole 6.
- NOISE** the noise source.
- HPF** the high-pass filter.

### LPF-2 : RESONANCE



Resonance amount is controlled from this parameter page. A portion of the output of the filter is fed-back to the input causing a resonance peak in the output at high levels, changing the characteristic of the sound passing through the filter. At very high settings the filter may self-oscillate and make noise even without any input signal - watch your speakers!



Try high resonance settings with EG modulation of the resonance and filter cut-off frequency to get a classic 'acidic' sound ...

### LPF-2 : OUTPUT



This parameter page sets the level of the audio signal passing into the final mixer stage. Note that when chaining the output of this filter to the input of another filter this setting is not relevant - it only sets the level to the final mixer.

## 10.9 Output stage

### OUTPUT



The final parameter page is the main output stage. This is where the level of the outputs of the filters are mixed and sent out of the **MOTAS-6** audio out connectors (mono signal **B** and headphones **A**). Usually an EG controls this level to allow the sound to be off when no keys are pressed. However, of course, this does not have to be so: by setting EG modulation to zero and increasing this parameter page offset it is possible to have a free-running output sound.

The output can be optionally passed through a selection of

analogue diode clipping circuits.

### Output options

This parameter page also allows control of which audio signal is input to the filter.

View and edit the additional options by pressing ← or → when the active item is the basic offset.





- NORMAL ( DRY )** 'dry': no clipping distortion applied.
- SOFT CLIP** soft-clip enabled.
- DRY+SOFT CLIP** dry + soft-clip.
- HARD CLIP** hard-clip.
- DRY+HARD CLIP** dry + hard-clipping.
- SOFT+HARD CLIP** soft + hard-clipping.
- DRY+SOFT+HARD** dry + soft-clipping + hard-clipping.

Typically, increased clipping produces a louder, harsher sound.





Use the oscilloscope feature to study the effect of the clipping options on the output waveform.

## 11 Patch summary



When not called upon for other functions, pressing  **1**,  **2**,  **3**,  **4** or  **5** changes the active patch (from 1 – 5) and shows a summary page of the patch settings similar to that shown in the screenshot below. The patch selected is shown in the bottom left-hand corner of the display.









The title on the top row shows the name of the patch.

Each of the boxes contains summary information corresponding to each of the 33 parameter pages. In faint on the far left of each box is shown a small horizontal bar that shows the rotary knob  **1** position which was saved with the patch. Next to this a similar but brighter bar shows the current rotary knob  **1** position. The larger bar on the right of each box shows the current value for that parameter page.



Use 'page lock' and study this page for a patch. Turn each rotary knob  **1** and watch the values change. Also, when you turn each rotary knob  **1** the title changes to show the name of the parameter page you are changing.

On the far right outside of the boxes is shown the output audio level as a vertical bar.

You can press the  **COPY** button and then press another preset button (, , ,  or ) to copy over a patch to another preset.

To enter vector morphing mode press  on the patch summary page. See chapter 13 for more details.



When a lot of modulation is being used it sometimes be difficult to work out what is going on! Use the patch summary page to help see an overview of the patch settings.

## 12 Load, save and copy

**MOTAS-6** allows up to 500 individual patches to be saved and loaded (in addition to the patches saved with sequences) and these are arranged into 10 'folders' or 'banks'.

The first 'bank' of 50 patches cannot be edited or erased from the **MOTAS-6** interface (but they can using external software).

Press and simultaneously to jump to the first patch in a bank. Press and simultaneously to jump to the first bank.

### 12.1 Load patch

To load a new patch press and the new patch is immediately recalled – you can immediately hear the newly loaded patch. The bank name and patch name is shown on the display. The patch will be loaded into the current active preset (1 – 5).

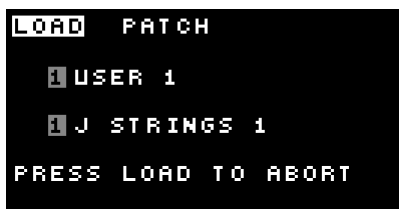

Turn the rotary encoder or push or to select the patches stored in non-volatile memory – they are loaded automatically as you select them. Use and to change bank. To abort and return to the previous patch you were working with press again at any time.

Empty unused patch locations are named **EMPTY** (in reverse colour), in this case no patch is loaded when they are selected (since they are empty).

When a new patch is loaded 'value lock' is automatically enabled to prevent any changes in the patch parameters from any rotary knob 1 changes. To immediately edit the loaded patch press and the parameter page you were previously on is shown. To explore the loaded patch without immediate editing press one of the buttons or the current preset button, to leave the 'load' page.

The load/save page remembers which patch you last accessed so when you load or save again you will return to the same patch location.

### 12.2 Save and erase patches

To save or erase the patch settings press .



#### Save patch

Turn the rotary encoder or push or to select the patch you want to save over. Use and to change bank. To abort and return press again at any time. Empty unused patch locations are named **EMPTY**.

Press to save over the selected patch with the current active patch. You will then be prompted to enter a save name for the patch – use the tactile buttons , and to enter letters directly or use the rotary encoder . Then press to confirm the save operation or to cancel.

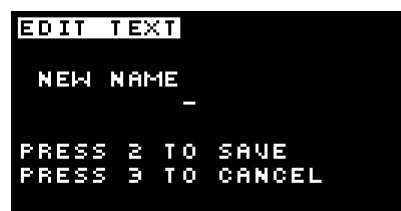

#### Save quick presets

To save the current 5 quick-access preset patches so that they are automatically loaded next time **MOTAS-6** is powered on press (in this case the selected save slot is irrelevant as the quick-access patches are stored in their own dedicated area).

#### Erase patch

Turn the rotary encoder or push or to select the patch you want to erase. Use and to change bank.

Press **S** to erase the selected patch (you will be asked to confirm by pressing **1** ).

### 12.3 Copy/Reset/Randomise

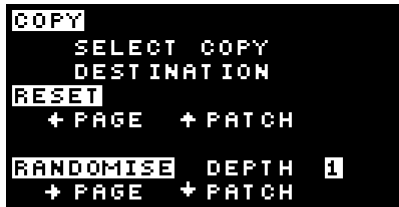

#### Copy

The settings for one parameter page can be copied to another page. First select the source page then press the **COPY** button and then select the destination page by turning a rotary knob **1**.

You can also copy the fast-access patches, see section 11.

#### Reset page

Press **←** to reset all parameters to default values on the current parameter page.

#### Reset patch

Press **↑** to reset the parameter settings to default values on *every* parameter page.

#### Randomise page

Press **→** to randomise the parameter settings on the current parameter page.

Turn the rotary encoder to set the randomisation depth from 1 to 10. At depth values of 8 or lower the randomisation algorithm changes the parameters relative to their current values. As the depth is increased the amount of deviation increases, and the possible parameters that are allowed to be modified is expanded. At depth settings of 9 or 10 the new randomised values do not depend on the current values.

#### Randomise patch

Press **↓** to randomise the entire patch (parameter settings on *every* parameter page). However, note that the pitches are not altered until the randomisation depth is 8 or greater and the main output stage page is not randomised until the depth value is 10.



Start from a patch that you like and use the randomise patch feature with a low depth setting (e.g 1–3) to explore new sounds similar to the starting point. Repeatedly applying the randomise will take the parameters on a 'random walk'



The pitches and main output stage pages are intentionally not randomised when you choose 'randomise patch' (except for depth 8 or greater for pitch, and 10 for main output) to more reliably allow you to hear something that is in tune with the starting point. However, due to the multiple signal paths and modulation options it is always possible that the randomisation will not give rise to any sound at all!

## 13 Vector morphing

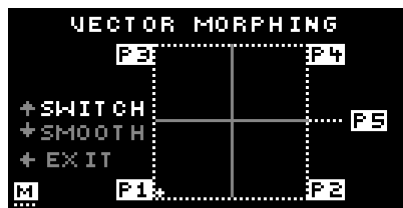

**MOTAS-6** has a unique 'vector morphing' feature. This allows blending of the parameters for the active patch from the patches in slots 1–4, in a 2-D space, using the morph-x and morph-y modulators (set these in section 17.6).

To enter vector morphing mode press whilst a preset page is displayed. The display will change to that shown above. The symbol **M** is shown in the bottom left of the display in vector morphing mode.

As the morph-x control is varied the patch parameters blend from left to right (**P1** / **P3** to **P2** / **P4**). Similarly as the morph-y control is varied the patch parameters blend from bottom to top (**P1** / **P2** to **P3** / **P4**). A small cross-hair on the display shows the current blend position. Also, the preset LEDs **2** will flash with a brightness reflecting the current blend amount from that preset.

The morph position can be in 1 of 4 quadrants corresponding to the patch presets 1–4. The 'dominant' preset is the one which belongs to the current quadrant. For example, if the morph position is in the lower left quadrant then preset P1 is dominant.

In vector morphing mode the patch parameters cannot be edited except for the parameter page offsets (using the rotary knobs ). This offset control feature can be enabled or disabled for each of the preset patches 1–4 individually. Pressing the preset buttons 1–4 toggles on/off individual patch control. When a patch is enabled for offset control a small dot is shown under the **M** icon.

There are two vector morphing modes: **SWITCH** and **SMOOTH**. To select 'switch' mode press . To enter 'smooth' mode press . You can change modes at any point even when the vector morphing overview is not shown.

In **SWITCH** mode as the morph position moves to a new dominant patch the discrete patch settings are suddenly switched over to match those of the new dominant preset. Discrete settings include parameters such as LFO waveshape, EG trigger settings and filter routing - any settings that cannot be smoothly adjusted. In **SMOOTH**

mode only the continuously variable parameters are adjusted (e.g LFO speed, offsets, EG attack), the discrete patch settings are not changed.

To exit the vector morphing mode press . The blend at that point is automatically stored into preset 5. The name of preset 5 will be changed to **UM XX-XX-XX-XX** where the xx values are the blend amounts in percent from the presets 1–4.

In vector morph mode the patch arpeggiator settings are set to those from patch preset #5 and stay with those settings until vector morph mode is exited. This allows the arpeggiator to be used even whilst vector morphing is active.

At the instant **SWITCH** mode is entered the discrete parameters immediately change to match those for the dominant patch. In **SMOOTH** mode the discrete parameters are held unchanging.

Populate 4 similar patches in presets 1–4 and then use vector morphing mode to blend between them in real-time. You could use the copy function to initially setup 4 identical patches and then edit each patch to provide the differences.

Populate 4 completely different patches in presets 1–4 then use vector morphing in **SMOOTH** mode. Now, in 3 of the 'corners' of the morphing space sounds will be generated that likely to be different from the original presets (since the discrete settings will not be changed). If you find a morphed result you particularly like then press **SAVE** and save the morphed result at that point.

## 14 Arpeggiator

The arpeggiator feature allows **MOTAS-6** to automatically play notes from a chord in succession with adjustable direction, number of octaves, pattern etc. The tempo is determined from the current active clock setting see section 17.1

Press the **ARPEG.** button to enter the arpeggiator settings.

Press and to navigate the pages. On each page press and to move between the options and use the rotary encoder to change the values. For fast value changing push the rotary encoder and turn at the same time.

Press and simultaneously to always jump to the first option on a page. Press and simultaneously to jump to **ARPEG PAGE 1**.

### 14.1 Main arpeggiator settings



**SOURCE** sets the active arpeggiator settings in use. This can be set to either those stored with the current patch shown as

**PATCH** or from global settings shown as **GLOBAL**. The global settings are stored to internal non-volatile memory when you exit the **ARPEG.** settings.

**MODE** sets the arpeggiator mode:

- **OFF** – arpeggiator off,
- **MIDI** – use incoming MIDI notes,
- **H-MIDI** use incoming MIDI notes holding after all keys released,
- **INT** – use internal preset chord (see section 14.3 below)
- **H-INT** – use internal preset with hold after all keys released (see section 14.3 below)

**DIRN** sets the direction (or order) of the notes played. Choose from:

- **UP** plays notes in ascending order of pitch
- **DOWN** plays notes in descending order of pitch

- **UPDN** plays in ascending and then descending order of pitch
- **UP2** plays in the order of the keys as played within each octave, but ascending octaves (when the **RANGE** is greater than 1)
- **DOWN2** plays in the order of the keys as played within each octave, but descending octaves (when the **RANGE** is greater than 1)
- **U/D2** plays in the order of the keys as played within each octave, but ascending and then descending octaves (when the **RANGE** is greater than 1)
- **RAND** plays the notes in random order.

**PATTERN** sets the timing pattern of the arpeggiator. From very fast **32T** (48 per bar) to a very slow **1** (1 note per bar), with triplet, standard and dotted values. Values greater than 1 are a selection of preset patterns instead of regular timing intervals labelled from **A** to **F**.

**RANGE** sets the arpeggiator octave range from **1** to **10** to set the number of octaves to play the arpeggios over.

### 14.2 More arpeggiator settings



Page 2 has further arpeggiator settings.

**SWING** sets the 'swing' of the timing. At 50% the timing is as per the **PATTERN** settings otherwise alternate notes have increased and decreased timings.

**LENGTH** sets the 'length' of each played note from 0% to 99%. This changes how long the notes are 'held' down as they are played by the arpeggiator.

**DELAY** sets a delay from -15 to +16 (normal setting would be 0) to allow correction of any synchronisation issues with external equipment (when using an external clock source).

**PATCH** (only available on global arpeggiator) allows the arpeggiator to automatically change patch presets on each new note:

- **OFF** patches are not changed

- **1-2** alternates between presets 1 and 2
- **1-3** in sequence: 1, 2, 3 ...
- **1-4** in sequence: 1, 2, 3, 4 ...
- **1-5** in sequence: 1, 2, 3, 4, 5 ...
- **UD3** 3-way up-down: 1, 2, 3, 2, 1 ...
- **UD4** 4-way up-down: 1, 2, 3, 4, 3, 2, 1 ...
- **UD5** 5-way up-down: 1, 2, 3, 4, 5, 4, 3, 2, 1 ...

Whilst the arpeggiator is playing you are free to edit the patches (and even load in new patches). The edited patch preset is lit strongly whilst the current playing preset is lit dimly on the preset LEDs ②.



Setup a series of drum kit sounds on the patch presets and then use the **PATCH** settings to play a rhythm! You can load in new patches to each preset and edit the parameters in real-time as the arpeggiator plays.

**NOTES** sets the number of notes to be played from the chosen chord from 1 to 8.

When the **CHORD** is set to **CUSTOM** then the 8 chord note values can be edited. Set the base note value from C1 to C5 (from 2 octaves below middle C to 2 octaves above). When the **CHORD** is NOT set to **CUSTOM** then the note values are greyed out but change to show the notes corresponding to the chosen chord.



If MIDI note data is received then the chord will be transposed to start from the first note held down.



Use the internal hold arpeggiator mode to play the arpeggiator when you don't have a MIDI controller keyboard around, to hear **MOTAS-6** play on its own.

### 14.3 Internal arpeggiator settings



Page 3 has the settings for the arpeggiator relevant in **INT** or **H-INT** modes only.

**CHORD** sets the type of chord used (i.e. which notes are used for the arpeggiator sequence).

**CUSTOM** uses up to 8 notes as defined lower down on this page. Otherwise choose from notes played from following chords:

- **MAJOR** major triad chord (C, CM)
- **MINOR** minor triad chord (Cm, Cmin)
- **AUG** augmented triad chord (Caug, C<sup>+</sup>)
- **DIM** diminished triad chord (Cdim, C<sup>o</sup>)
- **DIM7** diminished 7th chord (C<sup>o7</sup>, Cdim<sup>7</sup>)
- **M7B5** half diminished 7th chord (C<sup>o7</sup>, Cm<sup>7b5</sup>)
- **MINOR7** minor 7th chord (Cm<sup>7</sup>, Cmin<sup>7</sup>)
- **MINOR7** minor major 7th chord (Cm<sup>M7</sup>, Cm<sup>maj7</sup>)
- **DOM7** dominant 7th chord (C<sup>7</sup>, Cdom<sup>7</sup>)
- **MAJOR7** major 7th chord (CM<sup>7</sup>, CM<sup>7</sup>)
- **AUG7** augmented 7th chord (C<sup>+</sup>7, Caug<sup>7</sup>)
- **M7+5** augmented major 7th chord (C<sup>+</sup>M<sup>7</sup>, CM<sup>7+5</sup>)

## 15 Pattern sequencer

**MOTAS-6** features a 'pattern sequencer' which allows 1 bar patterns to be created, edited and played. Each pattern can contain a series of notes, parameter changes and controller events. There are 96 time-steps per pattern (which correspond to the 24 PPQN MIDI ticks).

The start-time, pitch, velocity, duration, micro-tune and patch of each note can be adjusted. In pattern mode each 1-bar pattern plays in a loop. The start and end time of the pattern can be adjusted. In record mode the note data can be recorded into the active pattern using incoming MIDI data.

In sequence mode a series of patterns can be played, one after the other in a track. Each pattern can be repeated, transposed and time-offset adjusted.

There are 15 patterns in memory at any time. Individual patterns can be named and saved. In sequence mode any of the patterns in memory can be played. When a sequence is saved all the patterns, patches in memory and sequence data is saved together.

The tempo of the playback is synchronised to the current clock (see section 17.3).

### 15.1 Control overview

Press to play/stop the pattern/sequence, to rewind the position to the start and to enter record mode.

When in record mode the recording LED indicator flashes (situated next to the button) and the symbol **R** flashes on the display. MIDI input to **MOTAS-6** as well as live patch changes (from rotary knobs , rotary encoder etc. ) are recorded (and can later be edited).

Press to toggle between pattern mode (shown by **P** on the top row of the display) and sequence mode (shown by **S** on the top row of the display). In pattern mode only the current active pattern is played (in a loop). In sequence mode the patterns in the sequence are played as determined by the sequence settings.

### 15.2 Pattern edit mode

To enter pattern edit mode press the button.

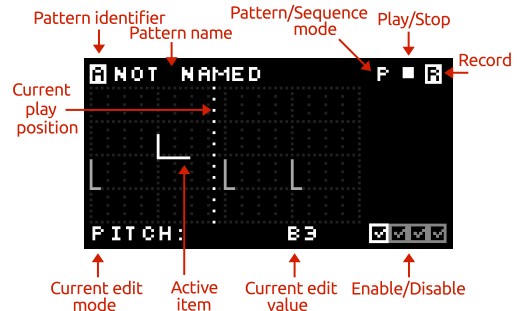

The active pattern can be selected using the and buttons. There are 15 to choose from **A**, **B**...**O**. Each can be re-named when they are saved.

Each pattern represents 1 bar of events (4 quarter notes with 24 time-steps per quarter note). There are 4 pages of event types. The active page is shown by the highlighted enable/disable icon in the lower right corner.

To change the active page press one of the following four buttons:

- note page
- discrete parameters page
- continuous parameters page
- modulation controllers page

Repeated pressing of the same button toggles whether the data in that page is active or ignored (shown by a cross or a tick in the bottom right hand side of the display).

The active item is shown flashing. To move to the next item press , to move the previous item press . To delete the current item press and to insert a new item press .

To change the value of the active item turn the rotary encoder .

#### Note edit page

Press to create, edit and delete notes in the active pattern. Up to 30 notes can be stored in each pattern.

Press to change to pitch edit mode. Then each note can be selected and the pitch changed. Similarly press to edit each each note's velocity, to edit the position in time of the note, to edit the note's duration and to edit the microtune (from 0–98 cents).



Press **PATCH** to edit the patch preset setting of the note. A setting of '-' means the patch is not changed otherwise the note will play using the patch value (1-5) set. Note that the sequence patch change setting (if set and if in sequence mode) over-rides these pattern note settings.



Set up a series of percussive sounds on presets 1-5 and use the **PATCH** settings to play the different sounds in the pattern for a rhythm track. **MOTAS-6** can change sounds very rapidly (< 1ms) and so you can enjoy quite complex multi-sound patterns. You can also edit the sounds as you play!

### Discrete parameter/Continuous parameter/Modulations edit pages

There are 3 pages with editing features in common. To record events press and adjust patch settings/controllers to record changes as the pattern is playing. Whilst recording the changes are not played back, and the recording is always in 'overwrite' mode.

There are 2 edit modes: press **PITCH** / **VELOCITY** to enter 'change value' mode. Alternatively, press **TIME** / **DURATION** / **MICRO-TUNE** / **PATCH** to enter 'change time' mode.

Press and hold to create a series of new values and then use the and buttons to select the events and the rotary encoder to change the values/times.

Press and hold to delete a series of values.



To create new discrete or continuous events enter record mode and adjust the patch settings as the pattern plays. These recorded events can be then be edited. Note that only the value of the event, not the type, can be edited. For example, if events of type 'master pitch' have been recorded these events cannot be changed to another type such as 'lpf1 resonance'.

### Discrete parameter edit page

Press **PARAMS** to view, edit and delete discrete patch parameters (such as changes to the filter routing). Press

**PARAMS** repeatedly to toggle on/off playback of the values.



### Continuous parameter edit page

Press **PARAMS-C** to view, edit and delete continuous patch parameters (such as filter cut-off frequency). Press **PARAMS-C** repeatedly to toggle on/off playback of the values.

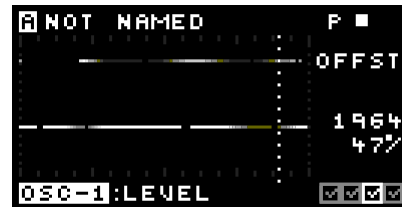

Note that (due to memory limitations) the number of discrete and continuous parameter events that can be stored is limited to 290 per pattern.

### Modulations edit page

Press **MODS** to view, create, edit and delete events for modulations **M1**, **M2**, **M3** and **M4**. Press **MODS** repeatedly to toggle on/off playback of the values.



### Edit pattern start/end time

The start and end times of each pattern can be set. Press the or and turn the rotary encoder to edit the start/end times.

## 15.3 Load/save/copy patterns

Patterns can be loaded and saved in much the same way as for patches (see section 12). There are 7 banks of patterns each containing 8 patterns. Press the **LOAD** or

👆 **SAVE** buttons when in pattern edit mode to access loading and saving.

Patterns can be copied (from one pattern to another in memory) – press the 👆 **COPY** button when in pattern edit mode. Another feature under the copy page is to clear or set a series of values automatically.

## 15.4 Sequence edit mode

To enter sequence mode press the 👆 **SEQUENCE** button.

Here the patterns in memory can be played in any order as a sequence, with up to 2 parallel 'tracks'.

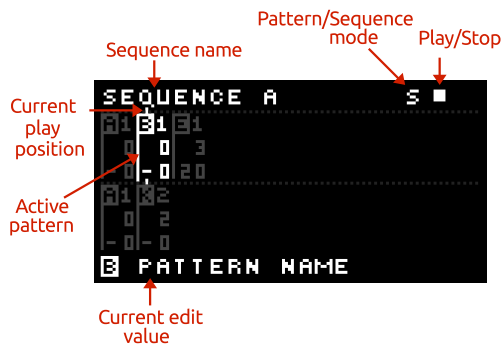

Press 👆 **+** to insert a pattern at the current point or press 👆 **-** to remove a pattern from the sequence. Use the 👆 **←** and 👆 **→** to move between the patterns in the sequence. A pattern in the sequence is active when brighter than the other patterns.

Use the 👆 **↑** and 👆 **↓** buttons to navigate the options for the active pattern:

<b>PATTERN NAME</b>	pattern to play at that slot
<b>REPEATS</b>	set number of repeats
<b>TRANSCOPE</b>	transpose in semitones
<b>PATCH</b>	change patch for the pattern
<b>T-OFFSET</b>	shift the timing of the pattern in units of 6 clock ticks (0 – 8)

## 15.5 Load/save sequences

Sequences can be loaded and saved in much the same way as for patches (see section 12). There are 2 banks of sequences each containing 8 sequences. Press the 👆 **LOAD**

or 👆 **SAVE** buttons when in sequence edit mode to access loading and saving.

When a sequence is saved the sequence data, all of the patterns *and* all 5 patch presets are saved together. Also the global microtuning preset and internal tempo is saved. This means that every detail of the sequence is recorded. When a sequence is loaded you have the choice to load in either all of this data or any of the separate parts.



💡 Load in only the sequence and pattern data (not the patch data) to try a sequence playing with new sounds that were not used when the sequence was created.

💡 Use the sequence saving to allow saving of a further 80 patches in addition to the regular patch saving area (5 x 2 x 8 = 80)!

## 16 Monitor

Press  **MONITOR** to enter monitor mode. There are 4 types of monitor mode: Volume level, MIDI, Oscilloscope and Spectrum Analyser.

To leave monitor mode press another control button or turn a parameter control (when 'page-lock' is not enabled). When monitor mode is enabled again the last selected mode is recalled.

Press  and  to navigate the different modes. A detailed description of each mode is given in the sections below.

### 16.1 Volume level monitor

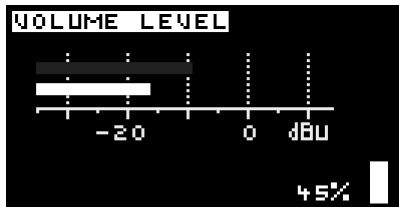



This mode shows the current master volume level as a percentage and a vertical bar at the right of the display adjusted by the volume knob **3**. This is the level controlling the output on the main out **B** and headphones output **A**.

At the top of the display, a dimmed horizontal signal level monitor bar shows the average audio level in approximate dBu (0 dBu is 0.775 V or 1 mW into a 600  $\Omega$  load) which would be output on the main audio out **B** when the volume is set to maximum (100%). Underneath the top bar, the approximate dBu actually present on the main audio out **B** is shown.

 The signal level monitor has similar response time to a traditional analogue VU meter

#### Limiters

Press  and  to toggle the audio limiter function. When enabled the output levels will be attenuated automatically to not exceed approximately 0 dBu on the main audio out **B**. When the limiting is activated **LIMIT** will appear on the display.

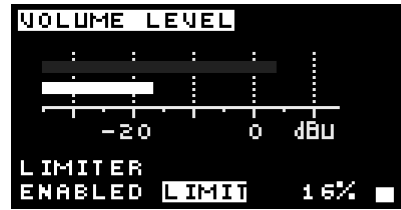



 **MOTAS-6** can generate very strong audio signals, use the limit feature to prevent excessive output levels, or use for creative effects!

 Turn the volume fully down when connecting audio amplification to avoid damaging external equipment from loud pops.



 Be careful not to listen at too high a volume level especially when using headphones attached to **A**, to avoid damaging your hearing.

### 16.2 MIDI in monitor

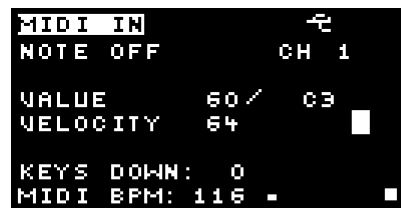
This mode shows incoming MIDI data on either the MIDI in connector **F** (shown by the ) or the USB MIDI interface **G** (shown by the )



Depending on the data coming in the display will change. In the example screenshot above the last data received was a note-off event over the USB interface on channel 1 with note value 60 (C3).

 Panic combination: pressing the rotary encoder  and  simultaneously will turn off all playing notes and reset controllers.

**i** MIDI events coming in on the MIDI in port **F** can be automatically sent out again on the MIDI out port **E** without any processing (MIDI thru feature). See section 17.11.

**💡** If you don't seem to be getting **MOTAS-6** to play properly then use this MIDI diagnostics page to check that indeed the correct MIDI events are being received. If not then a common problem could be that you have not set up your external MIDI device correctly, or a cable is not connected, or **MOTAS-6** is set to the wrong MIDI receive channel.

If there is incoming MIDI clock data then the beats per minutes (BPM) of the clock is displayed at the bottom left of the screen.

### 16.3 Oscilloscope

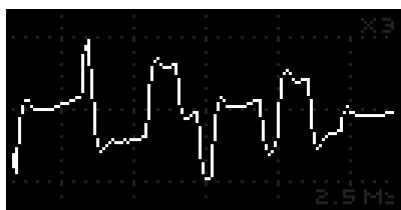

The oscilloscope mode allows you to 'see' the output audio waveform on the display. Time increases from left-to-right horizontally. Using the rotary encoder **⌚** the display time can be zoomed in or out. The horizontal scale is divided into divisions with faint vertical dashed lines. The current time scale is shown in the bottom right-hand side of the display. For example, in the figure the setting is 2.5 ms (i.e.  $2\frac{1}{2}$  thousandths of a second) per division.

Press **👆** **2** to pause/unpause the display (pause shown by **P** on the screen). Press **👆** **1** to auto-scale the vertical display (shown by an **R** on the screen). Note that the rescaling is limited and so for weak signals rescaling may not cause the waveform to fully fit the display. Press **👆** **↑** and **👆** **↓** to manually set the vertical display scale (from x1 to x16 zoom).

**i** The signals are measured on the audio output directly before the main volume control, so waveforms can still be seen even if the volume level is at the minimum setting.

**💡** Use the oscilloscope feature with 'page-lock' enabled whilst adjusting parameter controllers for e.g. filter cut-off or resonance to see the effect on the waveform!

**⚙️** Internally the oscilloscope feature works by digital sampling of the audio signal. The timebase is synchronised to the waveform as far as possible in order to prevent a 'rolling' display, however, depending on the waveform shape good synchronisation may not be possible.

### 16.4 Spectrum analyser

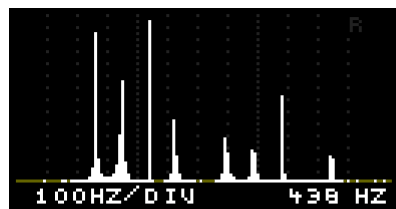

In spectrum analyser mode the amplitude (or volume level) of the audio signal versus frequency (or pitch) is shown. The horizontal scale is divided into divisions with faint vertical dashed lines. The current frequency scale is shown in the bottom left-hand side of the display. For example, in the figure the setting is 100 Hz per division.

Using the rotary encoder **⌚** the range of frequency displayed can be zoomed in or out.

Press **👆** **2** to pause/unpause the display (pause shown by **P** on the screen). Press **👆** **1** to auto-scale the vertical display (shown by an **R** on the screen). Note that the rescaling is limited and so for weak signals rescaling may not cause the waveform to fully fit the display. Press **👆** **↑** and **👆** **↓** to manually set the vertical display scale (from x1 to x16 zoom).



As in oscilloscope mode the signals are measured on the audio output directly before the main volume control, so the spectrum analysis can still be seen even if the volume level is at the minimum setting.

An automatic peak detector shows the frequency of the strongest peak at the bottom right-hand side of the display. For example, in the figure there are many signal peaks with the strongest one at 438 Hz.



Use the spectrum analyzer feature with 'page-lock' enabled whilst adjusting parameter controllers for e.g. filter cut-off or resonance to see the effect on the waveform!



Use the spectrum analyser mode to look at the harmonics of a waveform. With a sawtooth wave there are harmonics at 1f, 2f, 3f, 4f, 5f...all at decreasing strength. With a pure square wave there are harmonics at 1f, 3f, 5f, 7f...that is the main reason for the different sound to the ear. On the other hand, a pure sine wave tone has only the 1f component. Look at the spectrum analyser signals and listen to the differences!



Look at the spectrum analyser display with high filter resonance, and sweep the cut-off frequency around. You should see a moving strong signal peak at the resonance frequency.



Use the spectrum analyser to measure the frequency of a continuous bass note. Change the oscillator pitch and test out the response of your sound system or room resonances!



Internally the spectrum analyser feature works by digital sampling of the audio signal over a fixed time period. Then an FFT (Fast Fourier Transform) calculation is performed on the samples to determine the strength of the audio signal over a range of frequencies.

## 17 Setup

The setup pages allow setting of a variety of operating settings arranged over 16 pages. Press the **SETUP** button to enter the setup pages.

Press and to navigate the pages. On each page press and to move between the options and use the rotary encoder to change the values. For fast value changing push the rotary encoder and turn at the same time.

Press and simultaneously to always jump to the first option on a page. Press and simultaneously to jump to **SETUP PAGE 1**.

When you leave the setup pages the settings are saved to internal non-volatile memory (and so will be remembered when you power the unit off and on again) – except for patch-specific parameters as detailed below.

The current setup page is shown in the bottom right of the display.

### 17.1 Patch settings 1

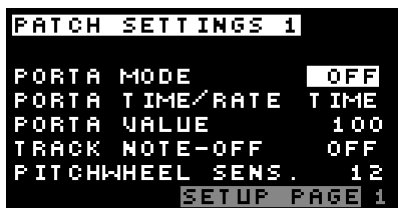

Here settings for the current patch can be set. Settings for the current patch are not saved automatically (but of course will be saved when the patch itself is saved).

**PORTA MODE** sets the portamento (glide) mode of the current patch. **OFF** turns off portamento, **LEGATO** gives portamento when notes are held and **ALWAYS** always gives a portamento effect.

**PORTA TIME/RATE** sets the portamento mode to constant time or constant rate.

**PORTA VALUE** sets the portamento time/rate from 0 (no effect – instant pitch change) to a maximum of 2000.

**TRACK NOTE-OFF** sets whether the pitch of the oscillators can update and the envelope generators can re-trigger after note-off events. There are 3 options: **OFF**, **PITCH** and **P+EG**. With settings **PITCH** and **P+EG** the pitch of the oscillators can up-

date on note-off events. With setting **P+EG** re-triggering of the EGs is enabled on note-off events.

**i** if oscillator pitch is set to track 'highest' note then setting **OFF** the pitch will not change when the highest note is released. However, with setting **PITCH** or **P+EG** the pitch may change to track the new 'highest' note still being played when the note is released. Similarly if EG trigger is set to track 'highest' note then with the setting **OFF** or **PITCH** the EG will not re-trigger when the highest note is released. However, with this setting **P+EG** the EG will re-trigger if there is a new 'highest' note still being played when the note is released.

**PITCHWHEEL** sets the pitch sensitivity of the current patch in semitones to incoming MIDI pitchbend. Set from 0 (no effect) to 24 (for 2 octaves shift at maximum pitchbend signal).

### 17.2 Patch settings 2



The option here is to set whether the LFOs in the patch are synchronised (reset) when the sequence or pattern is re-wound to the start or a MIDI START real-time message is received.

When **PATCH** is active then the current patch setting is used (**ON** or **OFF**). Alternatively, with **GLOBAL** active then the global setting is always used (overriding the current patch setting).

### 17.3 Tempo settings

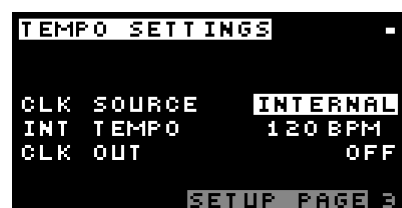

Here the global tempo settings can be set.

At the top right is shown a pulsing square in time with the current clock source (if present).

**CLK SOURCE** sets the active clock source for any synced LFOs, the arpeggiator and the pattern/ sequencer. Choose **EXT MIDI** for external MIDI (incoming on USB or MIDI in), **EXT CLK** for gate pulses on the CV/Gate inputs or **INTERNAL** for internal clock source.

The internal clock tempo **INT TEMPO** can be set from 30 to 300 beats per minute (bpm).

**CLK OUT** sets the options for output clock (only when in internal clock mode). Choose **OFF** to not send MIDI clock, **MIDI** to send MIDI clock on the MIDI out port, **USB** to send MIDI clock on the USB port and **MIDI+USB** to send MIDI clock on both the MIDI out port and USB.

## 17.4 MIDI channels

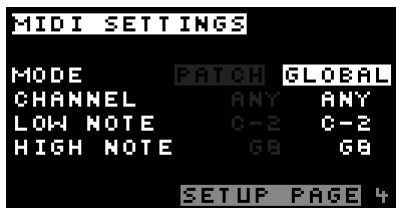

The response to incoming MIDI data can be defined for each patch (which is saved with the patch) and in addition as a global setting. **MODE** sets whether **MOTAS-6** responds to MIDI data according to the current patch setting or according to the global setting. When **PATCH** is set the editing is for the current patch and when **GLOBAL** is set the editing is for the global setting.

**CHANNEL** sets the MIDI channel to receive from. **ANY** means data on any MIDI channel will be accepted otherwise set from 1 to 16 to only respond to MIDI data on that channel. **LOW NOTE** sets the lowest MIDI note to process (lower ones are ignored). **HIGH NOTE** sets the highest MIDI note to process (higher ones are ignored). The range is from C-2 (MIDI note 0) to G8 (MIDI note 127), middle C (MIDI note number 60) is C3.

## 17.5 Modulators

**MODE** sets whether the 4 patch modulation sources **M**, **M**, **M** and **M** are set to the current patch settings or



to the global setting. When **PATCH** is set the editing is for the current patch and when **GLOBAL** is set the editing is for the global setting.

**MOD 1** sets the assignment of the incoming controller to **M**. The choice is from the standard MIDI controllers plus channel aftertouch, pitchbend and CV/gate channels 1 to 4. At the bottom of the display a longer name for the chosen source is displayed (channel aftertouch in the screenshot shown above). The same options are available to set the **M**, **M** and **M** modulation sources under **MOD 2**, **MOD 3** and **MOD 4**.

## 17.6 Morph/patch change



**MORPH-X** sets the modulation source to control the patch morphing in the x-direction. The choice is from the standard MIDI controllers plus channel aftertouch, pitchbend, CV/gate channels 1 to 4, keyboard note value and velocity. At the bottom of the display a longer name for the chosen source is displayed.

**MORPH-Y** sets the modulation source to control the morphing in the y-direction (in exactly the same way as for the **MORPH-X**).



If your MIDI keyboard has a joystick then that could be a perfect controller for the morphing x and y.

**PATCH** sets the option to fast-change between the 5 quick-access patches from an external source.

When **OFF** this feature is disabled. You can choose from **KBD** using the note-on value or **VEL** using velocity and,

in addition, any of usual MIDI/CV sources.

Since there are 5 quick-access patches the value from these sources is mapped to 1 of the 5 presets. With **KBD** each note up the keyboard cycles through the patches whilst the other options map linearly (so e.g. velocity  $\leq 25$  maps to patch 1,  $26 \leq \text{velocity} \leq 51$  maps to patch 2 ...)



Setup 5 different percussion sounds in the 5 quick-access presets and set **PATCH** to **KBD**. Then play this mini 'drumkit' from different keys.

## 17.7 CV/Gate inputs

```
CV/GATE MODES
IN 1 CV PITCH
IN 2 VELOCITY
IN 3 CLOCK+
IN 4 GATE+
CV+MIDI OFF
CV SMOOTHING 00
SETUP PAGE 7
```

**MOTAS-6** has 4 analogue CV/gate inputs **D**. Each input can be configured independently and set to one of the following 11 options:

- OFF** off (ignored)
- CV MOD** signal routed to modulation (M1 – M4)
- CV PITCH** signal routed to control master pitch
- VELOCITY** signal routed to control note velocity
- GATE+** signal triggers note on (on positive edges)
- GATE-** signal triggers note on (on negative edges)
- CLOCK+** signal triggers clock s (on positive edges)
- CLOCK-** signal triggers clock (on negative edges)
- CV OSC1** signal routed to control pitch of oscillator 1
- CV OSC2** signal routed to control pitch of oscillator 2
- CV OSC3** signal routed to control pitch of oscillator 3

**CV- $\rightarrow$ MIDI** allows the incoming CV signals to be con-

verted and sent over MIDI and/or USB MIDI.

**CV SMOOTHING** allows control over the smoothing (averaging) of the incoming analogue control voltages. This can be useful to create a delayed response to incoming CV. Normally set to 0 for no smoothing.

## 17.8 CV/gate offset and scaling

```
CV/GATE ADJUSTMENT
      OFFSET SCALE
IN 1  0.000 1.000
IN 2  0.000 1.000
IN 3  0.000 1.000
IN 4  0.000 1.000
SETUP PAGE 8
```

Here the offset and scaling of the input signals on the CV/gate inputs **D** can be independently set.

**OFFSET** sets the offset voltage (zero point) for the input from -9.999 to 9.999. **SCALE** sets the input scaling from -5.000 to 5.000.



Use the offset and scale values to match your external analogue CV/gate generating equipment to that of **MOTAS-6**. Use negative scaling to invert the signals.

## 17.9 Tuning

```
TUNING
      OFFSET 0 CT
      PATCH GLOBAL
BUILT-IN  23  0
  [Q] EQUAL 12
SETUP PAGE 9
```

**OFFSET** sets the master tuning of **MOTAS-6** from -100 to +100 cents (-1 semitone to +1 semitone).

**MOTAS-6** supports microtuning. There are 32 built-in tunings to choose from. All of the built-in tunings are set to have the same pitch at middle-C (C4 = MIDI note 60). Below is listed the built-in tunings with the cent offsets of each consecutive MIDI note (for the first octave) from middle-C. The number at the end of the name indicates the number of notes per octave (per doubling of pitch):



**EQUAL 12**

100, 200, 300, 400, 500, 600, 700, 800, 900, 1000, 1100

**PYTHAGOREAN 12**

114, 204, 294, 408, 498, 612, 702, 816, 906, 996, 1110

**WERKMEISTER 12**

90, 192, 294, 390, 498, 588, 696, 792, 888, 996, 1092

**KIRNBERGER 12**

90, 193, 294, 386, 498, 590, 697, 792, 890, 996, 1088

**VALLOTTI 12**

94, 196, 298, 392, 502, 592, 698, 796, 894, 1000, 1090

**MEANTONE 12**

76, 193, 310, 386, 503, 579, 697, 773, 890, 1007, 1083

**CORRETTE 12**

71, 182, 316, 386, 498, 569, 702, 773, 884, 1018, 1088

**LEVENS ORG 12**

112, 231, 316, 404, 598, 597, 702, 814, 933, 996, 1129

**GAMELAN 12**

0, 182, 267, 427, 510, 572, 702, 746, 996, 996, 1126

**JAPAN KOTO 12**

-608, -498, 386, 392, 590, 596, 702, 0, 386, 1088, 1094

**PRIME 5**

204, 386, 702, 884

**GOLDEN 5**

386, 471, 702, 841

**CLUSTER 6**

182, 316, 498, 814, 884

**PANPIPE 6**

270, 487, 676, 836, 1035

**APEX 7**

204, 386, 590, 702, 884, 1088

**SCOTBAG 7**

182, 386, 537, 680, 884, 1049

**TURKISH 7**

112, 386, 498, 702, 884, 996

**ZALZAL 7**

204, 355, 498, 702, 853, 996

**DORIAN MODE 7**

133, 316, 498, 702, 835, 1018

**TOMOS-33 7**

108, 224, 551, 625, 702, 1049

**DUDON THAI 7**

168, 336, 506, 675, 845, 1014

**LEBANONO 7**

150, 300, 500, 700, 800, 1000

**PERSIAN SAN 8**

130, 345, 490, 630, 850, 1035, 1137

**BAGPIPE 9**

-204, 0, 204, 386, 520, 702, 884, 1018

**DARREG GENUS 9**

63, 112, 182, 498, 702, 765, 814, 884

**10-TET 10**

128, 231, 359, 498, 603, 702, 841, 969, 1072

**PENTATRIAD 11**

182, 204, 386, 498, 590, 702, 884, 906, 996, 1088

**TURKISH 17**

68, 113, 204, 294, 362, 408, 498, 566, 611, 702, 792, 860, 906, 996, 1064, 1109

**PYTHAG ARAB 19**

90, 180, 204, 294, 384, 408, 475, 498, 588, 678, 702, 792, 882, 906, 973, 996, 1086, 1177

**INDIAN RAGA 22**

52, 102, 151, 204, 254, 326, 386, 441, 498, 551, 603, 649, 702, 754, 804, 855, 906, 969, 1027, 1088, 1143

**BAMBOO 23**

48, 102, 156, 204, 258, 312, 366, 414, 468, 522, 570, 624, 678, 726, 780, 834, 882, 936, 990, 1044, 1092, 1146

**CAIRO 26**

51, 93, 149, 200, 242, 293, 306, 349, 391, 442, 498, 540, 590, 647, 702, 740, 797, 808, 851, 902, 946, 1010, 1051, 1093, 1159

In addition, a further 32 user-specified tunings can be received via the standard MIDI 3-byte tuning dump command which can be sent using 3rd party tools such as the [Scala software](#). This feature allows defining the mapping of each of the 128 MIDI notes to any pitch. The user-specified tunings are stored in the internal non-volatile memory where the location (from 0 – 31) is set by the MIDI 'tuning program number' value.

There is the choice of using the global tuning or the tuning specified by the active patch. Note that the actual tuning data is not stored within the patch, only the tuning preset number. This means that if you change the tuning definition for a user-specified tuning any patches using that tuning will use the new definition when loaded.





**EQUAL 12** tuning is the most common tuning system used in Western music. This tuning system has equal frequency ratios between every note and 12 notes to the octave.

## 17.10 SysEx data backup

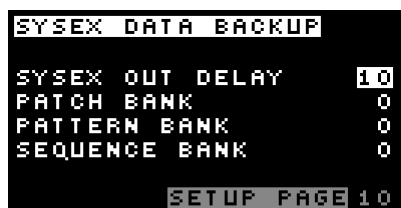
**SYSEX OUT DELAY** sets a delay in sending each packet of sysex data (such as patch settings) when using



**MOTAS-6** with external software over USB/MIDI. Sometimes too small a setting here will cause loss of packets by the receiving device so increase as required (a value of 10 is normally ok). The only downside to a larger number here is slower data transfer.

With **PATCH BANK**, **PATTERN BANK** and **SEQUENCE BANK** the chosen bank (using the rotary encoder ) can be sent over USB/MIDI when  **1** is pressed to allow data backup.

### 17.11 NRPN control + SysEx

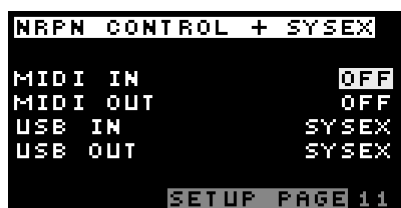

Here the response to NRPN (Non-Registered Parameter Number) MIDI data and SysEx (System Exclusive) MIDI data is configured. NRPNs are used by **MOTAS-6** to send and receive parameter changes in real-time.

**MIDI IN** sets which data is processed on the MIDI in connector . **OFF** ignores NRPN and SysEx data, **NRPN** processes NRPN data only, **SYSEX** processes SysEx data only, **NRPN+SYSEX** processes both NRPN and SysEx data.

**MIDI OUT** sets which data is sent on the MIDI out connector with the same options as for the **MIDI IN** with the addition of **THRU** which relays incoming MIDI data on the MIDI in port to the MIDI out port .

**USB IN** sets which incoming data is processed on the USB connector  with the same options as for **MIDI IN**.

**USB OUT** sets which data is sent out on the USB connector  with the same options as for **MIDI IN**.

### 17.12 System settings

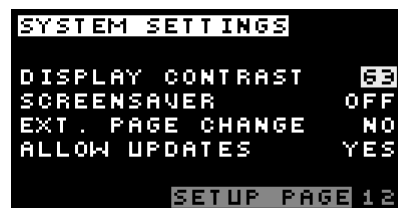

**DISPLAY CONTRAST** sets the display contrast from 0 to 127.















**SCREENSAVER** – when set to **ON** the display dims (to contrast level 0) after a certain period of inactivity.

**EXT. PAGE CHANGE** – when set to **ON** means that the displayed page may change to match that corresponding to the incoming external MIDI controller NRPN data.

**ALLOW UPDATES** – when set to **ON** allows system firmware updates to be received over MIDI/USB (note that also the **MIDI IN** or **USB IN** must be set to receive sysex to allow updates).

### 17.13 Custom settings



This page allows a start-up message to be displayed, press  **1** to enter your custom message. To enter the message the rotary encoder  selects characters or press the labelled letter keys  **A**,  **B** ...  **Z**. The   and   buttons move left and right in the message area. Press   for 'backspace',   for 'delete'. Press  **2** to cancel or  **3** to save the changes.

### 17.14 Calibration

**MOTAS-6** will have been factory calibrated, but sometimes re-calibration of the internal analogue circuitry may be necessary as the properties of the analogue components can vary with time and temperature.

One of the most important calibrations is the pitch of the oscillators. Some vintage analogue synths have a poor reputation for pitch stability but with **MOTAS-6**, thanks to advanced design and digital control, the stability is very good.



Press **1** to calibrate all parts of the analogue circuitry, **2** to calibrate the pitch of the oscillators and analogue noise level, **3** to calibrate the filter cut-off frequency and resonance levels or **4** to calibrate the PWM offsets (so that the 50% PWM setting is a perfect square wave). Whilst the calibration is running the audio output is disabled and the progress is displayed on the display. To abort any stage of the calibration process press **↓** (and then any other button). The full calibration process will usually take at least 40 seconds to complete.

Occasionally, due to the sensitive nature of some of the measurements the calibration may fail. Don't worry, just try calibrating again later.



The calibration of the oscillators internally sets the analogue oscillators at certain pitches and calibrates them against an accurate crystal frequency source, the calibration results are stored in internal non-volatile memory.



Since **MOTAS-6** has real analogue oscillators and filters these will drift a small amount in frequency over time and temperature (helping to give the rich sound quality). Occasionally you may wish to run the calibration particularly if the unit is moved from one extreme of temperature to another or after a long time (say several months).

## 17.15 Calibration values

This diagnostic page displays the current calibration values (determined from the calibration process), for reference only.

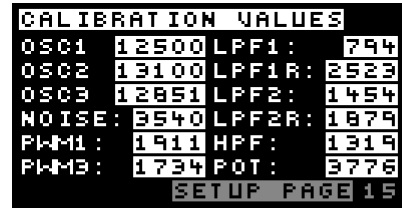

## 17.16 System status

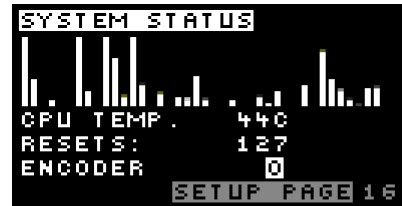

This diagnostic page shows a series of bar charts representing the current settings of the 33 potentiometers, the approximate CPU temperature, the number of power cycles of the unit and the rotary encoder signal.

## 17.17 Version info



This page shows (at the top left) a set of 3 unique serial numbers for your **MOTAS-6** product, UI and main PCB versions, as well as the firmware version and the firmware build date.

Pressing **1** on this page allows all of the user settings to be initialised to default values.



Initialising the settings means that all the stored calibration values will be lost as well as modulation assignments, MIDI settings, tuning, cv/gate settings etc. Basically all the settings under the **SETUP** pages will be initialised to default values.

## 18 Real-time patch change recording

**MOTAS-6** can send and receive MIDI NRPN messages to allow external recording and control of patch settings – see 17.11.

When a patch parameter is changed using the rotary knobs ❶, rotary encoder ❷ or buttons ❸ a series of 4 MIDI controller messages are sent:

- NRPN MSB #99 (0x63 in hex)
- NRPN LSB #98 (0x62)
- data entry MSB #6 (0x06)
- data entry LSB #38 (0x26)

The same format of messages, if received via USB or MIDI, cause the current patch to change accordingly.

The NRPN messages indicate exactly which parameter is being changed whilst the data entry messages contain the new parameter value. The first message (controller 99) is sent with the data value from the following table, denoting the parameter page being changed. If the data is for a global source (such as a shared EG or LFO) then the data value is zero.

Parameter Page	NRPN MSB data
N/A (global parameter)	0
Master pitch	1
Oscillator 1 Level	2
Oscillator 1 Pitch	3
Oscillator 1 Triangle Level	4
Oscillator 1 Sawtooth Level	5
Oscillator 1 PWM	6
Oscillator 1 PWM Level	7
Oscillator 2 Phase Mod.	8
Oscillator 2 Level	9
Oscillator 2 Pitch	10
Oscillator 2 Triangle Level	11
Oscillator 2 Sawtooth Level	12
Oscillator 2 Square	13
Oscillator 2 Sub Level	14
Oscillator 3 Phase Mod.	15
Oscillator 3 Level	16
Oscillator 3 Pitch	17
Oscillator 3 Triangle Level	18
Oscillator 3 Sawtooth Level	19
Oscillator 3 PWM	20
Oscillator 3 PWM Level	21
Noise Level	22
Mix Level	23
Low-pass Filter 1 cut-off	24
Low-pass Filter 1 resonance	25
Low-pass Filter 1 level	26
High-pass Filter cut-off	27
High-pass Filter level	28
Feedback/Ext in Level	29
Low-pass Filter 2 cut-off	31
Low-pass Filter 2 resonance	32
Low-pass Filter 2 Level	33
Output Level	35

In the case of a page-related parameter changing (i.e. NRPN MSB value not zero) then the second message sent (con-

troller 98) has the data value from the following table, denoting the parameter from that page being changed.

Page data	NRPN LSB data
Offset	1
EG mod depth	5
EG delay	10
EG attack	11
EG decay	12
EG sustain	13
EG release	14
LFOx mod depth	20
LFO frequency	25
LFO mod depth	26
M1 level	30
M1 alternate dest. level	31
M1 unipolar	32
M2 level	35
M2 alternate dest. level	36
M2 unipolar	37
M3 level	40
M3 alternate dest. level	41
M3 unipolar	42
M4 level	45
M4 alternate dest. level	46
M4 unipolar	47
Velocity level	50
Velocity alternate dest. level	51
Velocity unipolar	52
Note level	55
Note alternate dest. level	56
Note unipolar	57
Page option 1	64
Page option 2	65
EG source	70
EG retrigger	71
EG restart	72
EG shape	75
EG shape multi	76
EG unipolar	78
LFO source	80
LFO waveform	85
LFO trigger	86
LFO single shot	87
LFO output mode	88
LFO pitch track	89
M1 destination	90
LFO freq mod LFOx	92
LFO freq mod EG	93
M2 destination	95
M3 destination	100
M4 destination	105
velocity destination	110
note destination	115

In the case of a global parameter changing (i.e. NRPN MSB value was zero) then the second message sent (controller 98) has the data value from the following table, denoting the global parameter.

Global data	NRPN LSB data
LFOx 1 frequency	4
LFOx 2 frequency	5
LFOx 3 frequency	6
LFOx 4 frequency	7
EGx 1 delay	12
EGx 2 delay	13
EGx 3 delay	14
EGx 4 delay	15
EGx 1 attack	20
EGx 2 attack	21
EGx 3 attack	22
EGx 4 attack	23
EGx 1 decay	28
EGx 2 decay	29
EGx 3 decay	30
EGx 4 decay	31
EGx 1 sustain	36
EGx 2 sustain	37
EGx 3 sustain	38
EGx 4 sustain	39
EGx 1 release	44
EGx 2 release	45
EGx 3 release	46
EGx 4 release	47
portamento mode	52
portamento time	53
portamento time/rate	54
M1 source	64
M2 source	65
M3 source	66
M4 source	67
LFOx 1 trigger	72
LFOx 2 trigger	73
LFOx 3 trigger	74
LFOx 4 trigger	75
LFOx 1 single-shot	76
LFOx 2 single-shot	77
LFOx 3 single-shot	78
LFOx 4 single-shot	79
LFOx 1 waveform	80
LFOx 2 waveform	81
LFOx 3 waveform	82
LFOx 4 waveform	83
LFOx 1 pitch track	84
LFOx 2 pitch track	85
LFOx 3 pitch track	86
LFOx 4 pitch track	87
EGx 1 trigger	88
EGx 2 trigger	89
EGx 3 trigger	90
EGx 4 trigger	91
EGx 1 restart	96
EGx 2 restart	97
EGx 3 restart	98
EGx 4 restart	99
EGx 1 shape	104
EGx 2 shape	105
EGx 3 shape	106
EGx 4 shape	107
EGx 1 unipolar	110
EGx 2 unipolar	111
EGx 3 unipolar	112
EGx 4 unipolar	113
EGx 1 shape multi	114
EGx 2 shape multi	115
EGx 3 shape multi	116
EGx 4 shape multi	117

# Signal path diagram (simplified)

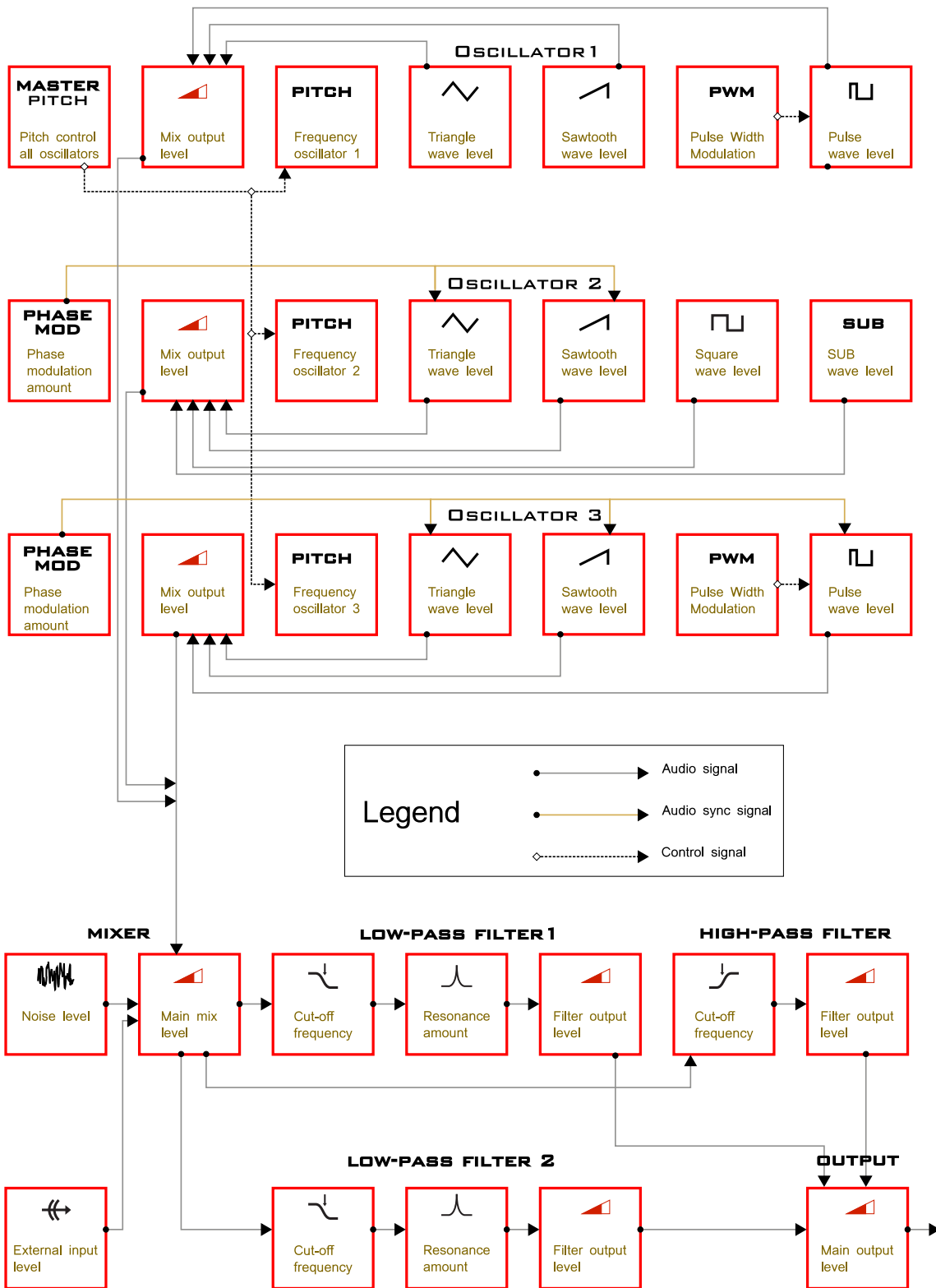



## Glossary



Here are some terms used in sound synthesis relevant to **MOTAS-6**.

**ADSR** – Abbreviation for Attack, Decay, Sustain and Release, the four stages of an envelope control commonly present on classic analogue synthesizers. **MOTAS-6** has a D-ADSR structure for its envelopes. That is Delay, Attack, Sustain, Decay, Release expanding on the usual ADSR envelope generator structure.

**Amplitude** – The strength of a sound's vibration. Amplitude corresponds to the musical term loudness.

**Continuous Controller (CC)** – A type of MIDI message used to transmit control commands. These commands are digital control signals for parameters such as volume, vibrato and panning. With **MOTAS-6** any of these controller codes can be mapped to each of the 4 modulation sources.

**Envelope** – An envelope describes the contour that affects the characteristics of a sound (pitch, tone and volume) over time. For example, when a string is plucked, its amplitude or volume begins strongly and decays gradually over time. To synthesize this effect an envelope can be applied to the level of the sound i.e. using a parameter page with the   symbol.

The initial part of the plucked sound is very bright, but then the brightness fades away. This describes a tonal envelope. To synthesize this effect an envelope can be applied to the cut-off frequency of one of the **MOTAS-6** low-pass filters i.e. using the parameter pages  .

We may also hear the frequency of the sound go slightly higher when the string is plucked, and then drop slightly as the note fades. This is the pitch envelope contour. To synthesize this effect an envelope can be applied to the frequency of the **MOTAS-6** oscillators i.e. pages  **PITCH**.

**Envelope Generator** – In **MOTAS-6** this is a modulation signal that has 5 stages in time: Delay, Attack, Decay, Sustain and Release (D-ADSR). This signal can be applied to the parameters of the patch to cause the sound to vary over time.

The Delay, Attack, Decay and Release segments are specified in units of time, while the Sustain segment is a simply a level setting.

The envelope is triggered by MIDI key presses.

Delay specifies the delay after the envelope is triggered until the envelope starts the Attack portion. Attack specifies the time taken for the envelope signal to rise to its maximum value. Decay specifies how quickly the onset of the envelope fades into the sustained portion. Sustain is the level at which the envelope sustains after the delay, attack and decay portions. Finally, Release determines how long the envelope takes to fade away when the envelope trigger is removed. Depending on the trigger mode the release phase starts when a key, or all keys are released.

**Filter** – A circuit that attenuates (reduces the strength of) some frequencies allowing other frequencies to pass through essentially unchanged. A filter has a cutoff frequency that determines the point at which frequencies begin to be attenuated. A low-pass filter is one in which frequencies above the cutoff frequency are attenuated and all frequencies below the cutoff are passed through.

A high-pass filter is one in which frequencies below the cutoff frequency are attenuated and frequencies above the cutoff are passed through. A bandpass filter has two cutoff frequencies that define a frequency band, outside of which the frequencies are attenuated.

**MOTAS-6** has 2 independent low-pass filters and one high-pass filter.

**Frequency** – The rate of vibration in Hertz (Hz or cycles per second). The average hearing range of the human ear is from 20 to 20,000 Hz. Frequency corresponds to the musical term 'pitch', but the two terms are not always interchangeable. Frequency is an objective measurement of a sound, while pitch is the perception of a sound, low, high, or mid-ranged. A low frequency corresponds to a low-pitched sound such as a bass; a high frequency sound corresponds to a high-pitched sound such as a piccolo. In music, a change in pitch of one octave higher equals a doubling of the frequency.

**Harmonic** – A sound is made up of simple vibrations at many different frequencies (called harmonics) that give a sound its particular character. This corresponds to the musical term timbre or tone color. A harmonic sound, such as a vibrating string, is one in which the harmonics are mathematically related by what is called the harmonic series. These sounds are typically pleasing to the ear and generally the consecutive vibrations have the same characteristic shape or waveform. An inharmonic sound, such as a crash cymbal, is one in which the harmonics are not mathematically related. Their waveforms look chaotic. White

noise is an inharmonic sound that contains equal signal levels at all frequencies. A sine wave is a 'pure' tone that has no harmonics.

**Low Frequency Oscillator** – Also called an LFO, this is a special type of oscillator that generates signals primarily below the range of human hearing (generally below 20 Hz but up to more than 400 Hz on **MOTAS-6**). LFOs are typically used as a source of modulation. For instance, an LFO with a triangle waveform, set to about 6 Hz and modulating the pitch of a VCO results in vibrato. Changing the LFO waveform to a square wave will result in a trill. An LFO modulating a VCA with a triangle wave creates tremolo.

**Mixer** – A circuit for combining multiple sound sources.

**Modulation** – Modulation is the use of a control signal to shape a sound parameter. Modulation has a source, a destination, and an amount. This could be as simple as the filter cutoff of a filter (a modulation destination) being changed by the rotary knob  1. Modulation is used in synthesis to create complex sounds and add interesting variation.

**Morphing** – a feature on **MOTAS-6** where you can smoothly change the sound settings from one patch to another using a MIDI controller.

**Noise** – A random audio signal having no fundamental, and where all the harmonics have equal strength with frequency (white noise) or decaying level at higher frequencies at a certain rate (pink noise). Noise can be used as either an audio or modulation source. When used as an audio source, noise can be used by itself to synthesize explosions or wind noises, or can be mixed with other waveforms to create noise artifacts, such as breath sounds.

**Oscillator** – A circuit that electronically 'vibrates'. When used as a sound source, an oscillator is the electronic equivalent of a vibrating reed, or string. An oscillator produces a pitched sound whose frequency is determined by one or more control voltages. Changes to these voltages correspond to changes in pitch. An oscillator's vibration can have different shapes or waveforms, such as a triangle, sawtooth, or square wave.

**MOTAS-6** has three oscillators for generating sounds.

**Phase modulation** – Also known as PM, Phase Modulation describes the technique of using one oscillator to modulate the phase of another. In PM, the modulating oscillator is called the 'modulator', while the other oscillator is known as the 'carrier'. The carrier oscillator is the one you

hear. When the modulator frequency is very low (about 6Hz), the effect is described as vibrato. As the modulator frequency is raised into the audio range, new modulation frequency components are created, and the effect is perceived as adding new overtones to the carrier signal. Phase Modulation is related (and is similar) to Frequency Modulation (FM) but the pitch stability is better. In fact, the classic 'FM synthesizers' from the 80s actually employed Phase Modulation...

**Pitch** – The subjective perception of sound. A bass guitar generates low pitches (low frequencies), while a flute generates high pitches (high frequencies).

**Pole (or poles)** – A term referring to the design of a filter circuit. In a low-pass filter each filter pole adds 6 dB/octave of attenuation to the filter response, so while a single pole filter has a 6dB/Octave response, a 4-pole filter has a 24dB/Octave response. **MOTAS-6** has 3 separate analogue filters. One is a low-pass up to 36-pole design with adjustable resonance, the second is a 4-pole low-pass filter with resonance and the third is a 2-pole high pass filter. The more poles the steeper the roll-off and the stronger the filtering effect.

**Portamento** – Also called glide, is the slowing down of pitch changes as you play different notes on the keyboard. Certain acoustic instruments, like the trombone or the violin, create this effect when the performer adjusts the tubing or string length. The rate of change of pitch can be set in constant time or constant rate mode.

**Sample and Hold (S&H)** – A circuit that generates a control voltage corresponding to the input signal at the time a trigger or gate signal is received. Sample and hold circuits usually employ white noise as a signal source, taking samples of this signal and holding that sample until the next sample is taken. The LFOs on **MOTAS-6** have a S&H waveform option.

**Sound** – Audible vibrations of air pressure. For electronic sounds such as those produced by a synthesizer, loudspeakers or headphones are used to translate the electrical vibrations into the changes in air pressure which we perceive as sound.

**Subtractive synthesis** – A method of creating tones using harmonically rich (bright) source material, and then removing (or in some cases emphasizing) various frequency components to create the desired sound. **MOTAS-6** employs subtractive synthesis in common with most other analogue synthesizers.



**Synthesis** – The generation of sound by electronic means, where programmer/performer has the ability to change the pitch, volume, timbre and articulation.

**Timbre** – Refers to the quality of a sound by its overtones. An unprocessed sawtooth wave has a bright timbre, while a triangle wave has a mellow timbre.

**Tremolo** – Low frequency amplitude modulation of the volume level. In synthesizers, tremolo is produced when a 5–7Hz LFO triangle or sine wave signal is applied to the volume level.

**Waveform** – The shape of an oscillator's vibration. This determines its timbre. Commonly used waveforms in subtractive synthesis are sawtooth, triangle, square, or rectangular. Different waveforms have different timbres. A sawtooth has the even and odd harmonics, and sounds bright and buzzy. A square wave has only odd harmonics, and sounds bright, but hollow, like a clarinet. A rectangular wave can vary in shape, but typically has a bright but thin sound. A triangle wave has the same odd harmonics as the square wave but the amplitudes lower in amplitude so that it sounds muted and flutelike.

**Vibrato** – a low frequency modulation of the pitch - giving a smooth warble sound. In synthesizers, vibrato is produced when a 5–7Hz LFO triangle or sine wave signal is applied to oscillator pitch, causing the pitch to deviate slightly above and below the base frequency.

# MIDI Implementation Chart

MIDI Implementation Chart v. 2.0 (Page 1 of 3)			
Manufacturer: Motas Electronics Limited. Model: Motas 6. Date: March 2020.			
	Transmit/Export	Recognise/Import	Remarks
<b>1. Basic Information</b>			
MIDI channels	1 – 16	1 – 16	see 17.4
Note numbers	No	0 – 127	see 17.4
Program change	No	0 – 4	changes active preset
Bank Select response? (Yes/No) If yes, list banks utilized in remarks column		No	
Modes supported : Mode 1: Omni-On, Poly (Yes/No) Mode 2: Omni-On, Mono (Yes/No) Mode 3: Omni-Off, Poly (Yes/No) Mode 4: Omni-Off, Mono (Yes/No) Multi Mode (Yes/No)		No No No No No	Can be set to receive on any channel see 17.4
Note-On Velocity (Yes/No)		Yes	
Note-Off Velocity (Yes/No)	No	No	
Channel Aftertouch (Yes/No)		Yes	see 17.5
Poly (Key) Aftertouch (Yes/No)		No	
Pitch Bend (Yes/No)		Yes	see 17.1
Active Sensing (Yes/No)		Yes	
System Reset (Yes/No)	No	No	
Tune Request (Yes/No)	No	No	
Universal System Exclusive: Sample Dump Standard (Yes/No)	No	No	3-byte bulk tuning dump see 17.9
Device Inquiry (Yes/No)	No	No	
File Dump (Yes/No)	No	No	
MIDI Tuning (Yes/No)	No	Yes	
Master Volume (Yes/No)	No	No	
Master Balance (Yes/No)	No	No	
Notation Information (Yes/No)	No	No	
Turn GM1 System On (Yes/No)	No	No	
Turn GM2 System On (Yes/No)	No	No	
Turn GM System Off (Yes/No)	No	No	
DLS-1 (Yes/No)	No	No	
File Reference (Yes/No)	No	No	
Controller Destination (Yes/No)	No	No	
Key-based Instrument Ctrl (Yes/No)	No	No	
Master Fine/Coarse Tune (Yes/No)	No	No	
Other Universal System Exclusive	No	No	
Manufacturer or Non-Commercial System Exclusive	Yes	Yes	Motas Electronics Ltd ID# : 00H 21H 2FH
NRPNS (Yes/No)	Yes	Yes	see 18
RPN 00 (Pitch Bend Sensitivity) (Yes/No)	No	No	
RPN 01 (Channel Fine Tune) (Yes/No)	No	No	
RPN 02 (Channel Coarse Tune) (Yes/No)	No	No	
RPN 03 (Tuning Program Select) (Yes/No)	No	No	
RPN 04 (Tuning Bank Select) (Yes/No)	No	No	
RPN 05 (Modulation Depth Range) (Yes/No)	No	No	
<b>2. MIDI Timing and Synchronization</b>			
MIDI Clock (Yes/No)	Yes	Yes	see 17.3
Song Position Pointer (Yes/No)	No	No	
Song Select (Yes/No)	No	No	
Start (Yes/No)	No	Yes	see 17.2
Continue (Yes/No)	No	Yes	
Stop (Yes/No)	No	Yes	
MIDI Time Code (Yes/No)	No	No	
MIDI Machine Control (Yes/No)	No	No	
MIDI Show Control (Yes/No)	No	No	
If yes, MSC Level supported	No	No	
<b>3. Extensions Compatibility</b>			
General MIDI compatible? (Level(s)/No)	No	No	
Is GM default power-up mode? (Level/No)			
DLS compatible? (Levels(s)/No) (DLS File Type(s)/No)	No No	No No	
Standard MIDI Files (Type(s)/No)	No	No	
XMF Files (Type(s)/No)	No	No	
SP-MIDI compatible? (Yes/No)	No	No	

**MIDI Implementation Chart v. 2.0 (Page 2 of 3)**

Manufacturer: Motas Electronics Limited. Model: Motas 6. Date: March 2020.

Control #	Function	Transmitted (Y/N)	Recognised (Y/N)	Remarks
0	MIDI Bank Select (MSB)	Y	Y	17.5
1	Modulation Wheel (MSB)	Y	Y	See 17.5
2	Breath Controller (MSB)	Y	Y	see 17.5
3		Y	Y	see 17.5
4	Foot Controller (MSB)	Y	Y	see 17.5
5	Portamento Time (MSB)	Y	Y	see 17.5
6	Data Entry (MSB)	Y	Y	see 17.5 and 18
7	Channel Volume (MSB)	Y	Y	See 17.5
8	Balance (MSB)	Y	Y	see 17.5
9		Y	Y	see 17.5
10	Pan (MSB)	Y	Y	see 17.5
11	Expression (MSB)	Y	Y	see 17.5
12	Effect Control 1 (MSB)	Y	Y	see 17.5
13	Effect Control 2 (MSB)	Y	Y	see 17.5
14		Y	Y	see 17.5
15		Y	Y	see 17.5
16	General Purpose Controller 1 (MSB)	Y	Y	see 17.5
17	General Purpose Controller 2 (MSB)	Y	Y	see 17.5
18	General Purpose Controller 3 (MSB)	Y	Y	see 17.5
19	General Purpose Controller 4 (MSB)	Y	Y	see 17.5
20		Y	Y	see 17.5
21		Y	Y	see 17.5
22		Y	Y	see 17.5
23		Y	Y	see 17.5
24		Y	Y	see 17.5
25		Y	Y	see 17.5
26		Y	Y	see 17.5
27		Y	Y	see 17.5
28		Y	Y	see 17.5
29		Y	Y	see 17.5
30		Y	Y	see 17.5
31		Y	Y	see 17.5
32	Bank Select (LSB)	N	N	
33	Modulation Wheel (LSB)	N	N	
34	Breath Controller (LSB)	N	N	
35		N	N	
36	Foot Controller (LSB)	N	N	
37	Portamento Time (LSB)	N	N	
38	Data Entry (LSB)	Y	Y	see 18
39	Channel Volume (LSB)	N	N	
40	Balance (LSB)	N	N	
41		N	N	
42	Pan (LSB)	N	N	
43	Expression (LSB)	N	N	
44	Effect Control 1 (LSB)	N	N	
45	Effect Control 2 (LSB)	N	N	
46		N	N	
47		N	N	
48	General Purpose Controller 1 (LSB)	N	N	
49	General Purpose Controller 2 (LSB)	N	N	
50	General Purpose Controller 3 (LSB)	N	N	
51	General Purpose Controller 4 (LSB)	N	N	
52		N	N	
53		N	N	
54		N	N	
55		N	N	
56		N	N	
57		N	N	
58		N	N	
59		N	N	
60		N	N	
61		N	N	
62		N	N	
63		N	N	

**MIDI Implementation Chart v. 2.0 (Page 3 of 3)**

Manufacturer: Motas Electronics Limited. Model: Motas 6. Date: March 2020.

Control #	Function	Transmitted (Y/N)	Recognised (Y/N)	Remarks
64	Sustain Pedal	Y	Y	see 17.5
65	Portamento On/Off	Y	Y	see 17.5
66	Sostenuto	Y	Y	see 17.5
67	Soft Pedal	Y	Y	see 17.5
68	Legato Footswitch	Y	Y	see 17.5
69	Hold 2	Y	Y	see 17.5
70	Sound Controller 1 (default: Sound Variation)	Y	Y	see 17.5
71	Sound Controller 2 (default: Timbre / Harmonic Quality)	Y	Y	see 17.5
72	Sound Controller 3 (default: Release Time)	Y	Y	see 17.5
73	Sound Controller 4 (default: Attack Time)	Y	Y	see 17.5
74	Sound Controller 5 (default: Brightness)	Y	Y	see 17.5
75	Sound Controller 6 (GM2 default: Decay Time)	Y	Y	see 17.5
76	Sound Controller 7 (GM2 default: Vibrato Rate)	Y	Y	see 17.5
77	Sound Controller 8 (GM2 default: Vibrato Depth)	Y	Y	see 17.5
78	Sound Controller 9 (GM2 default: Vibrato Delay)	Y	Y	see 17.5
79	Sound Controller 10 (GM2 default: Undefined)	Y	Y	see 17.5
80	General Purpose Controller 5	Y	Y	see 17.5
81	General Purpose Controller 6	Y	Y	see 17.5
82	General Purpose Controller 7	Y	Y	see 17.5
83	General Purpose Controller 8	Y	Y	see 17.5
84	Portamento Control	Y	Y	see 17.5
85		Y	Y	see 17.5
86		Y	Y	see 17.5
87		Y	Y	see 17.5
88		Y	Y	see 17.5
89		Y	Y	see 17.5
90		Y	Y	see 17.5
91	Effects 1 Depth (default: Reverb Send)	Y	Y	see 17.5
92	Effects 2 Depth (default: Tremolo Depth)	Y	Y	see 17.5
93	Effects 3 Depth (default: Chorus Send)	Y	Y	see 17.5
94	Effects 4 Depth (default: Celeste [Detune] Depth)	Y	Y	see 17.5
95	Effects 5 Depth (default: Phaser Depth)	Y	Y	see 17.5
96	Data Increment	Y	Y	see 17.5
97	Data Decrement	Y	Y	see 17.5
98	Non-Registered Parameter Number (LSB)	Y	Y	see 18
99	Non-Registered Parameter Number(MSB)	Y	Y	see 18
100	Registered Parameter Number (LSB)	Y	Y	see 18
101	Registered Parameter Number(MSB)	Y	Y	see 18
102		Y	Y	see 17.5
103		Y	Y	see 17.5
104		Y	Y	see 17.5
105		Y	Y	see 17.5
106		Y	Y	see 17.5
107		Y	Y	see 17.5
108		Y	Y	see 17.5
109		Y	Y	see 17.5
110		Y	Y	see 17.5
111		Y	Y	see 17.5
112		Y	Y	see 17.5
113		Y	Y	see 17.5
114		Y	Y	see 17.5
115		Y	Y	see 17.5
116		Y	Y	see 17.5
117		Y	Y	see 17.5
118		Y	Y	see 17.5
119		Y	Y	see 17.5
120	All Sound Off	N	Y	
121	Reset All Controllers	N	Y	
122	Local Control On/Off	N	N	
123	All Notes Off	N	Y	
124	Omni Mode Off	N	N	
125	Omni Mode On	N	N	
126	Poly Mode Off	N	N	
127	Poly Mode On	N	N	

## IV MIDI SysEx messages



This appendix is for reference purposes mainly for those wishing to develop software to communicate with **MOTAS-6**. MIDI system exclusive (SysEx) messages allow transfer of bulk data such as patch data, screenshot images and firmware updates. Further details are available on request.

The following table shows the message format that can be used by a connected MIDI device to request data from **MOTAS-6**

MIDI SysEx request message format	
SysEx byte	Description
0xF0	start
0x00	Motas Electronics identifier
0x21	Motas Electronics identifier
0x2F	Motas Electronics identifier
0x06	product id (6 = motas-6)
X	MIDI channel byte 'X'
0x00	reserved
CB	SysEx command byte 'CB'
P	SysEx parameter byte 'P'
0xF7	end

The following table shows the message format for bulk data messages that can be sent or received. In the case of larger data transfers they are split up and sent in multiple smaller packets using the start/continue/end byte indicator.

MIDI SysEx bulk data transfer message format	
SysEx byte	Description
0xF0	start
0x00	Motas Electronics identifier
0x21	Motas Electronics identifier
0x2F	Motas Electronics identifier
0x06	product id (6 = motas-6)
X	MIDI channel 'X'
0x00	reserved
CB	SysEx command byte 'CB'
SCE	SysEx start/continue/end byte 'SCE' 0x47 = start, 0x48 = continue, 0x49 = end
A	SysEx parameter 'A'
B	SysEx parameter 'B'
C	SysEx parameter 'C'
DD ...*	multiple data bytes 'DD' encoded from original data bytes 'XX' to limit each byte value <= 0x7F required by MIDI protocol
CRC †	only present if this is an 'end' packet – 4-byte CRC of the original data bytes 'XX'
0xF7	end

MIDI SysEx Command Listing		
Command description	SysEx command 'CB'	SysEx parameter(s)
<i>Request commands</i>		
Request screenshot bitmap	0x0A	–
Request oscilloscope trace	0x0B	–
Request bulk data	0x0C	–
Request info	0x0E	–
Request global data	0x0F	–
Request screenshot bitmap compressed	0x10	–
Request status	0x11	P = 0bxxxxxxx1 : auto page change on P = 0bxxxxxx1x : show monitor page
Request patch	0x14	–
Request patch bank	0x15	P = bank number
Request pattern	0x19	–
Request pattern bank	0x1A	P = bank number
Request sequence	0x1E	–
Request sequence bank	0x1F	P = bank number
Request abort process	0x4B	–
<i>Data transfer</i>		
Screenshot	0x28	–
Oscilloscope data	0x29	–
Info	0x2A	–
Screenshot compressed ‡	0x2B	–
Global data	0x2D	–
Patch	0x32	A = 0x73 B = current preset#
Patch bank	0x33	A = bank# B = index#
Pattern	0x37	A = 0x73 B = current pattern#
Pattern bank	0x38	A = bank# B = index#
Send sequence	0x3C	A = 0x73 B = 0
Send sequence bank	0x3D	A = bank# B = index#
Send status	0x3E	–
Send bulk data	0x0C	–
<i>Receive-only commands</i>		
Receive bulk data	0x0D	
Receive firmware	0x46	

\* To decode the bytes values to the original data a sequence of 8 bytes can be processed using the following c-code algorithm:

```

1 for (i = 0; i < 8; i++) {
2     if (i == 0) {
3         msbByte = byte[i];
4         msbCount = 1;
5     } else {
6         decodedByte = byte[i] | ((msbByte << msbCount) &
7             0x80);
8         msbCount++;
9     }
}

```

† The CRC algorithm is 32 bit, uses the initial value 0xFFFFFFFF, polynomial value 0x04C11DB7 and final XOR value of 0x00000000

‡ Compression algorithm details available on request, email [support@motas-synth.uk](mailto:support@motas-synth.uk)

## V Specifications

<b>Input power connection</b> .....	12 V DC ( $\pm 10\%$ ) on 2.1 mm socket (positive centre pin)
<b>Power/current consumption</b> .....	< 10 W / < 800 mA
<b>Dimensions (w x d x h)</b> .....	408 mm x 218 mm x 58 mm
<b>Weight</b> .....	approx. 3 kg
<b>Operating temperature</b> .....	15–30 °C
<b>Storage temperature</b> .....	5–40 °C
<b>Sound generation</b> .....	analogue with digital control
<b>Construction</b> .....	stainless steel and aluminium panels (top/rear panels painted or with clear anti-fingerprint coating), stainless steel fixings and solid real-wood end-cheeks
<b>Display</b> .....	128 x 64 pixel OLED monochrome graphic display
<b>User interaction</b> .....	34 rotary potentiometers, 33 tactile buttons and a rotary encoder with push-button
<b>Audio input</b> .....	mono input on 6.35 mm ( $\frac{1}{4}$ " ) phone socket
<b>CV/Gate inputs</b> .....	4 CV/Gate analogue inputs on 3.5 mm mono sockets. Input impedance 22 k $\Omega$ . Voltage range 0 ...12V max.
<b>Audio outputs</b> .....	mono master out and headphones out on 6.35 mm ( $\frac{1}{4}$ " ) phone sockets
<b>MIDI connections</b> .....	MIDI in and MIDI out on 5-pin DIN sockets
<b>USB</b> .....	USB MIDI device on type-B connector

## **VI** EU Declaration of Conformity

### **Type of Equipment**

Electronic music synthesizer audio equipment.

### **Object of the Declaration:**

Named product: Motas-6 Synthesizer

### **Manufacturer:**

Motas Electronics Limited,  
Windsor House, Station Court, Station Road, Great Shelford, Cambridge, CB22 5NE, United Kingdom.  
email: info@motas-synth.uk  
web: www.motas-synth.uk

**This declaration of conformity is issued under the sole responsibility of the manufacturer.  
The object of the declaration described above is in conformity with the relevant Union harmonisation legislation:**

DIRECTIVE 2014/30/EU of the European Parliament and of the Council of 26 February 2014 on the harmonisation of the laws of the Member States relating to electromagnetic compatibility.

DIRECTIVE 2011/65/EU of the European Parliament and of the Council of 8 June 2011 on the restriction of the use of certain hazardous substances in electrical and electronic equipment.

### **Standards to Which Conformity Is Declared:**

(For DIRECTIVE 2014/30/EU ) EN 55032:2012 and EN 55103-2:2009

### **Signed for and on behalf of Motas Electronics Limited:**



### **Place of issue:**

Cambridge, United Kingdom.

### **Date of issue:**

25th September 2017

### **Name and position:**

Dr J M Hayes, director.

